



SHAKTI
Industries



Aspiring Growth
Through Technology



Company's Technical performance

Shakti Industries produces high quality forged steel fittings and unions, available in an array of classes & material grades for any application.

All connections, under constant engineering review, meet high quality standards. Each piece must pass through strict inspection before leaving the factory. Our stringent evaluations focus on material control, manufacturing quality and design control.

Our forge shop has complete lines of forging and support equipment and automated production lines. Next generation machining system delivers high volume capabilities with uncompromising

Material Grades

ASTM and ASME steel forgings

Carbon Steels:

- A105, A266 C11 to C14, SA765 Gr.2
- A372 Gr.A / Gr.B
- A350 LF2 C11 to C13 for low temperature service
- A516 Gr.60 and Gr.70
- S45C
- A738C / S355J2 / 1.0577

Low alloy steels

Ferritic alloy steel forgings for high-pressure and high-temperature parts, such as boilers and pressure vessels.

- A182 / A336 F1, F5, F9, F11, F22, F91, F92

Austenitic stainless steels

- A182 F304 / 304L (UNS S30403), F310 (UNS S31000)
- A182 F316/316L (UNS S31603), F316Ti, F317/317L (UNS S31703)
- A182 F321 (UNS S32100), F347 (UNS S34700)
- A182 F44 (254SMO), 904L (UNS N08904)
- 17-4 PH, 15-5 PH (SUS 630)

Alloy Steels (for machine building)

- 42CrMo4 (Q+T) / AISI 4140 / DIN EN 1.7225
- 25CrMo4 / AISI 4130 / DIN EN 1.7213
- 34CrNiMo6 / AISI 4340 / DIN EN 1.6582
- AISI 8660 Tripel Alloy Steel

High Strength / high yeild carbon steels

- A694 F42, F45, F52, F55, F60, F65, F70

Ferritic stainless steels

- A182 F429, F430, F440A

Martensitic stainless steels

- A182 F6a, A182 F6NM

SOCKET - WELDING FITTINGS



SHAKTI
Industries

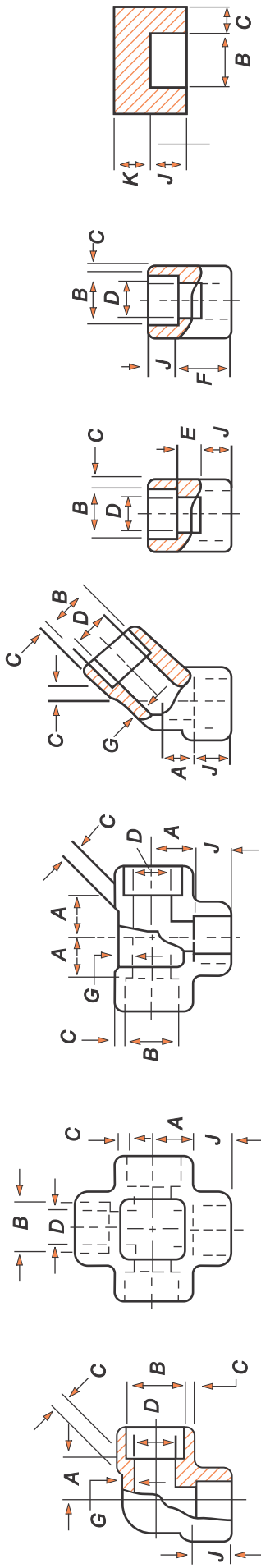

DIMENSIONS OF SOCKET - WELDING FITTINGS (ANSI B16.11)

Nominal Pipe Size (mm)	B Socket Bore dia. B (Note [1])		C Socket Wall Thickness, C				G Body Wall				J Min Depth of Socket				A Center to Bottom of Socket, A				E F A E F Laying Lengths				F A E F Tolerances ±				F End Wall Thickness K_{min}										
	Class Designation		3000		6000		9000		Class Designation		3000		6000		9000		Class Designation		3000		6000		9000		Class Designation		3000		6000		9000						
	Agv. Min.		Agv. Min.		Agv. Min.		Agv. Min.		Min.		Min.		Min.		Min.		Class Designation		E		F		A		E		F		Class Designation		3000		6000		9000		
	3000		6000		9000		3000		6000		9000		3000		6000		9000		90 deg Elbows, Tees and Crosses		45 deg Elbows		Coupl-ings, F		Half Coupl-ings, F		Coupl-ings, F		Class Designation		3000		6000		9000		
6	11.2	7.6	3.18	3.96	3.43	2.41	3.15	9.5	11.0	11.0	11.0	8.0	8.0	8.0	6.5	16.0	1.0	1.5	1.0	1.5	1.0	4.8	6.4				
8	10.8	6.1	3.78	4.60	4.01	3.02	3.68	9.5	11.0	13.5	8.0	8.0	8.0	6.5	16.0	1.0	1.5	1.0	1.5	1.0	4.8	6.4				
10	14.6	10.0	4.01	5.03	4.37	3.20	4.01	9.5	13.5	15.5	8.0	11.0	6.5	17.5	1.5	3.0	1.5	3.0	1.5	4.8	6.4			
15	18.0	13.3	4.67	5.97	5.18	9.35	8.18	3.73	4.78	7.47	9.5	15.5	19.0	25.5	11.0	12.5	15.5	9.5	22.5	1.5	3.0	1.5	3.0	1.5	6.4	7.9	11.2			
20	21.8	15.0		
20	27.6	21.7	4.90	6.96	6.04	9.78	8.56	3.91	5.56	7.82	12.5	19.0	22.5	28.5	13.0	14.0	19.0	9.5	24.0	1.5	3.0	1.5	3.0	1.5	6.4	7.9	12.7		
25	27.2	20.2	5.69	7.92	6.93	11.38	9.96	4.55	6.35	9.09	12.5	22.5	27.0	32.0	14.0	17.5	20.5	12.5	28.5	2.0	4.0	2.0	4.0	2.0	9.6	11.2	14.7		
32	33.9	25.9	6.07	8.92	7.92	12.14	10.96	4.85	6.35	9.70	12.5	27.0	32.0	35.0	17.5	20.5	22.5	12.5	30.0	2.0	4.0	2.0	4.0	2.0	9.6	11.2	14.2		
40	42.7	34.3	6.35	9.35	8.18	12.70	11.12	5.08	7.14	10.15	12.5	32.0	38.0	38.0	20.5	25.5	25.5	12.5	32.0	2.0	4.0	2.0	4.0	2.0	11.2	12.7	15.7		
50	48.8	40.1	6.93	10.92	9.50	13.84	12.12	5.54	8.74	11.07	16.0	38.0	41.0	54.0	25.5	28.5	28.5	19.0	41.0	2.0	4.0	2.0	4.0	2.0	12.7	15.7	19.0		
65	61.2	51.7	8.76	12.70	11.12	7.01	16.0	41.0	28.5	19.0	43.0	2.5	5.0	2.5	5.0	2.5	15.7	19.0	
80	73.9	61.2	9.52	13.84	12.12	7.62	16.0	57.0	32.0	19.0	44.5	2.5	5.0	2.5	5.0	2.5	19.0	22.4	
100	89.8	76.4	10.69	15.70	14.14	8.56	19.0	66.5	41.0	19.0	48.0	2.5	5.0	2.5	5.0	2.5	22.4	28.4	
100	115.7	103.8
100	115.2	100.7

*Upper and lower values for each size are the respective maximum and minimum dimensions.

SOCKET - WELD AND THREADED UNION
and FORGED THREADED FITTINGS



SHAKTI
Industries

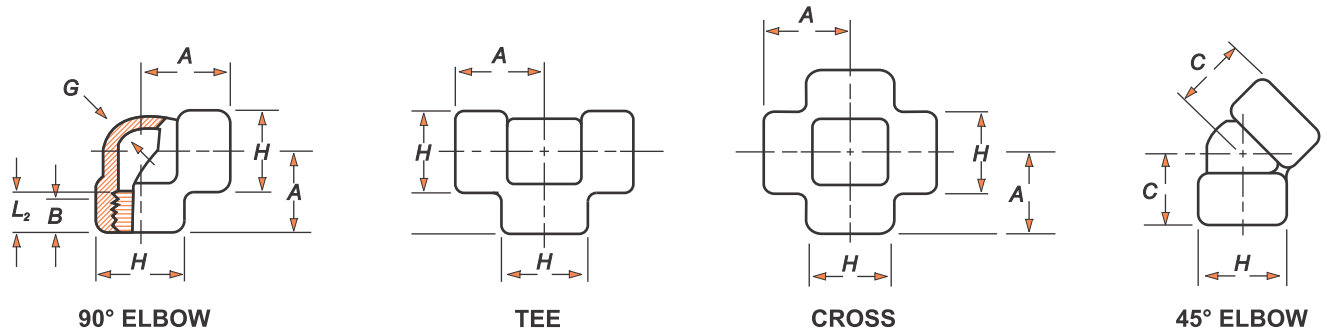

DIMENSIONS OF FORGED THREADED FITTINGS [ANSI B 16.11]

Nominal Pipe Size		A			C			H			G			B	
		Center-to-End Elbows, Tees, Crosses, A			Center-to-End 45 deg Elbow, C			Outside Diameter of Band, H			Min. Wall Thickness, G			Min. Length of Thread	
(mm)	(Inch)	2000	3000	6000	2000	3000	6000	2000	3000	6000	2000	3000	6000	B	L2
6	1/8	21	21	25	17	17	19	22	22	25	3.18	3.18	6.35	6.4	6.7
8	1/4	21	25	28	17	19	22	22	25	33	3.18	3.30	6.60	8.1	10.2
10	3/8	25	28	33	19	22	25	25	33	38	3.18	3.51	6.98	9.1	10.4
15	1/2	28	33	38	22	25	28	33	38	46	3.18	4.09	8.15	10.9	13.6
20	3/4	33	38	44	25	28	33	38	46	56	3.18	4.32	8.53	12.7	13.9
25	1	38	44	51	28	33	35	46	56	62	3.68	4.98	9.93	14.7	17.3
32	1.1/4	44	51	60	33	35	43	56	62	75	3.89	5.28	10.59	17.0	18.0
40	1.1/2	51	60	64	35	43	44	62	75	84	4.01	5.56	11.07	17.8	18.4
50	2	60	64	83	43	44	52	75	84	102	4.27	7.14	12.09	19.0	19.2
65	2.1/2	76	83	95	52	52	64	92	102	121	5.61	7.65	15.29	23.6	28.9
80	3	86	95	106	64	64	79	109	121	146	5.99	8.84	16.64	25.9	30.5
100	4	106	114	114	79	79	79	146	152	152	6.55	11.18	18.67	27.7	38.0

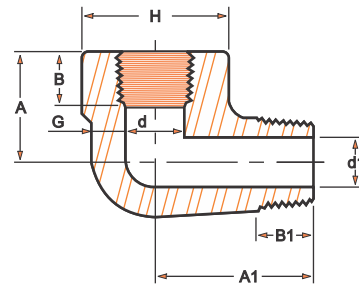

STREET ELBOWS

Dim Nom. Pipe Size	H	A	d			G (Min)	B (Min)	B1 (Min)	H	A	d			G (Min)	B (Min)	B1 (Min)
			A1	d1	(Min)						(Min)	B1 (Min)	A1			
3000Lbs									6000Lbs							
1/4	25	22.2	31.7	11.2	7	3.30	8.0	10.3	33	25.4	38.1	11.2	3.0	6.60	8.0	10.3
3/8	33	25.4	38.1	14.5	9	3.51	9.0	10.4	38	28.6	41.2	14.5	4.7	6.98	9.0	10.4
1/2	38	28.6	41.2	15.7	13	4.09	11.0	13.6	46	34.9	47.6	15.7	6.3	8.15	11.0	13.6
3/4	46	34.9	47.6	20.9	16	4.32	12.5	13.8	56	44.5	57.2	20.9	11.1	8.53	12.5	13.8
1	56	44.5	57.2	26.6	20	4.98	14.5	17.3	62	50.8	66.7	26.6	15.2	9.93	14.5	17.3
1-1/4	62	50.8	66.7	35.0	28	5.28	17.0	18.0	75	54.0	71.4	35.0	22.8	10.59	17.0	18.0
1-1/2	75	54.0	71.4	40.9	30	5.56	18.0	18.4	84	63.5	84.0	40.9	27.9	11.07	18.0	18.4
2	84	63.5	84.0	52.5	40	7.14	19.0	19.3	-	-	-	-	-	-	-	-

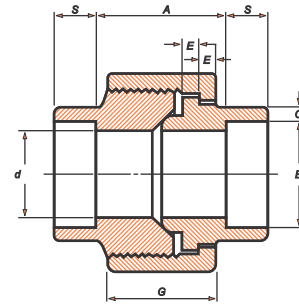
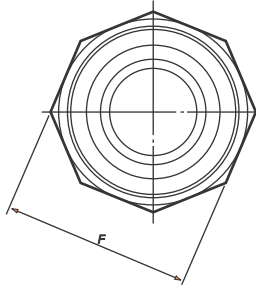

SOCKET - WELDING FITTINGS - DIMENSIONS OF UNIONS BS-3799 1974

Nominal Size		S	A	B	C	d	E	F	G
		3000							
Depth of Socket (min.) S		Distance between bottoms of sockets (min.) A	Bore diameter of sockets (min.) B	Socket wall thickness (min.) C	Bore diameter of union d*	Thickness of shoulder (min.) E	Width A/F of nut (min.) F	Height of nut (min.) G	
in	mm	mm	mm	mm	mm	mm	mm	mm	mm
1/8	(6)	10	17	10.7	3.2	6.8	3.2	32	16
1/4	(8)	10	17	14.1	3.3	9.2	3.2	32	18
3/8	(10)	10	17	17.6	3.5	12.5	3.2	36	19
1/2	(15)	10	18	21.8	4.1	15.5	4.0	41	21
3/4	(20)	13	20	27.4	4.3	21.0	4.8	50	24
1	(25)	13	26	34.1	5.0	26.5	4.8	60	25
1 1/4	(32)	13	28	42.9	5.3	35.0	5.6	70	29
1 1/2	(40)	13	30	49.0	5.6	40.5	5.6	78	30
2	(50)	16	36	61.0	6.1	52.0	6.4	95	37
2 1/2	(65)	16	57	73.8	7.7	62.0	9.6	125	48
3	(80)	16	70	89.7	8.3	78.0	12.7	140	51

*Bore diameter d corresponds to schedule 40 pipe. Subject to tolerances see 2.6.

*Outside diameter of pipe must be specified if dimensions are not in accordance with BS 1600.

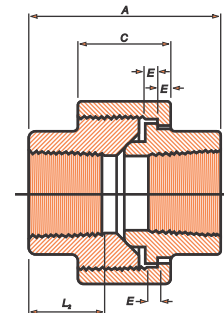
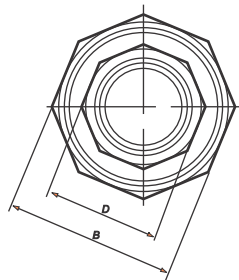

SCREWED FITTINGS DIMENSIONS OF UNIONS BS-3799 1974

Material Size		A	B	C	D	E
		3000				
End to End		Width A/F taken nut (min.) B	Height of union nut (min.) C	Width A/F of ends (min.) D	Thickness of Shoulder (min.) E	Length of thread (min.) L1
in	mm	mm	mm	mm	mm	mm
1/8	(6)	40	32	16	17	6.70
1/4	(8)	43	32	18	19	10.21
3/8	(10)	48	36	19	22	10.36
1/2	(15)	51	43	21	30	13.56
3/4	(20)	57	50	24	36	13.86
1	(25)	64	60	25	41	17.34
1 1/4	(32)	70	70	29	50	17.93
1 1/2	(40)	79	78	30	60	18.38
2	(50)	89	95	37	70	19.22
2 1/2	(65)	118	125	48	85	28.89
3	(80)	121	140	51	100	30.48

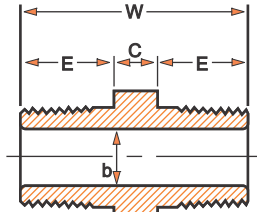

FULL SIZE

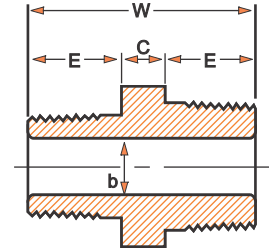
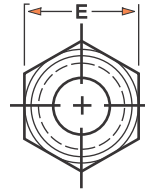

REDUCING SIZE

HEX NIPPLES THREADED BS-3799 1974

Nominal Size		A	W	E	b		C	F
DN	Inch	(Min.)	(Min.)	(Min.)	3000 (Min.)	6000 (Min.)	(Min.)	(Min.)
6	1/8"	11	26	10	5	2	6	-
8	1/4"	15	36	15	8	6	6	-
8x6	1/4"x1/8"	15	31	15	5	2	6	10
10	3/8"	18	40	16	11	8	8	-
10x8	3/8"x1/4"	18	39	16	8	6	8	15
15	1/2"	22	48	20	14	11	8	-
15x10	1/2"x3/8"	22	44	20	11	8	8	16
15x8	1/2"x1/4"	22	43	20	8	6	8	15
20	3/4"	27	52	21	19	13	10	-
20x15	3/4"x1/2"	27	50	21	14	11	9	20
20x10	3/4"x3/8"	27	46	21	11	8	9	16
25	1"	35	60	25	24	17	10	-
25x20	1"x3/4"	35	56	25	19	13	10	21
25x15	1"x1/2"	35	55	25	14	11	10	20
40	1-1/2"	50	68	26	38	30	16	-
40x25	1-1/2"x1"	50	67	26	24	17	16	25
40x20	1-1/2"x3/4"	50	63	26	19	13	16	21
40x15	1-1/2"x1/2"	50	62	26	14	11	16	20
50	2"	62	71	27	49	39	17	-
50x40	2"x1-1/2"	62	70	27	38	30	17	26
50x25	2"x1"	62	70	27	24	17	18	25
50x20	2"x3/4"	62	65	27	19	13	17	21
50x15	2"x1/2"	62	65	27	14	11	18	20

* Dimensions in millimeter.

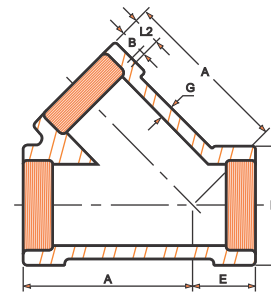

45° Lateral Tee Threaded

DN	Nom. Pipe Size	2000LB						3000LB					
		Length of Thread (Min)		A	E	G ⁽²⁾ (Min)	H ⁽²⁾	Length of Thread (Min)		A	E	G ⁽²⁾ (Min)	H ⁽²⁾
		B ⁽³⁾	L ⁽³⁾					B ⁽³⁾	L ⁽³⁾				
15	1/2"	10.9	13.6	46	20	3.18	33	10.9	13.6	55	23	4.09	38
20	3/4"	12.7	13.9	55	23	3.18	38	12.7	13.9	65	26	4.32	46
25	1"	14.7	17.3	65	26	3.68	46	14.7	17.3	73	31	4.98	56
32	1-1/4"	17.0	18.0	73	31	3.89	56	17.0	18.0	82	35	5.28	62
40	1-1/2"	17.8	18.4	82	35	4.01	62	17.8	18.4	113	42	5.56	75
50	2"	19.0	19.2	113	42	4.27	75	19.0	19.2	136	56	7.14	84
65	2-1/2"	23.6	28.9	136	56	5.61	92	-	-	-	-	-	-

(1) Dimensions in Millimeters.

(2) Dimensions refer to ANSI B16.11

(3) Dimensions of BSP and PT are available if required.

(4) Dimensions may vary according to the customer's and manufacturer's requirement.

(5) Dimension B is minimum length of perfect thread.

The length of useful thread (B plus threads with fully formed roots and flat crests) shall not be less than L2 (effective length of external thread) required by American National Standard for pipe threads (ANSI/ASME B1.20.1)

PLUGS & BUSHINGS
and THREAD FITTINGS



SHAKTI
Industries

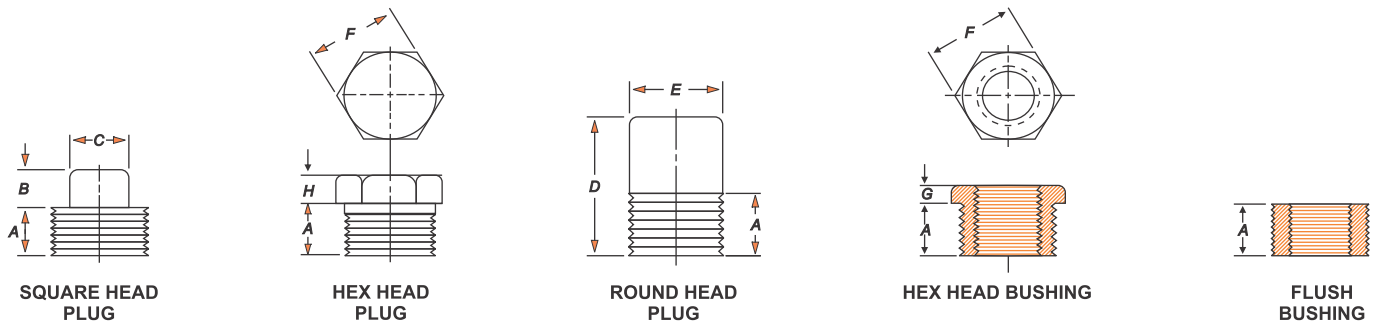

DIMENSIONS OF PLUGS & BUSHINGS [ANSI B 16.11]

Nominal Pipe Size		A	B	C	E	D	F	G	H
		Min. Length	Square Head Plugs		Round Head Plugs		Hex Plugs and Bushings		
			Min. Square Height	Min. Width Flats,	Nominal Head Diameter	Min. Length	Nominal Width Flats	Min. Hex Height	
(mm)	(Inch)	A	B	C	E	D	F	G	H
6	1/8	10	6	7	10	35	11	...	6
8	1/4	11	6	10	14	41	16	3	6
10	3/8	13	8	11	18	41	18	4	8
15	1/2	14	10	14	21	44	22	5	8
20	3/4	16	11	16	27	44	27	6	10
25	1	19	13	21	33	51	36	6	10
32	1. 1/4	21	14	24	43	51	46	7	14
40	1. 1/2	21	16	28	48	51	50	8	16
50	2	22	18	32	60	64	65	9	18
65	2. 1/2	27	19	36	73	70	75	10	19
80	3	28	21	41	89	70	90	10	21
100	4	32	25	65	114	76	115	13	25

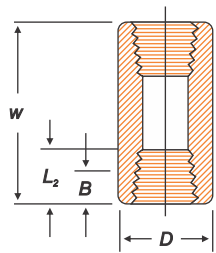

COUPLING

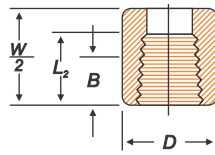

HALF COUPLING

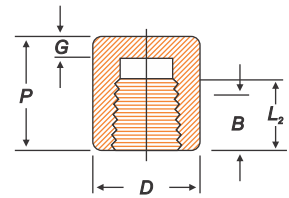

CAP

DIMENSIONS OF THREAD FITTINGS [ANSI B 16.11]

Nominal Pipe Size		W	P		D		G		B	
		End to End Couplings	End to End Caps		Outside Diameter		Min. End Wall Thickness		Min. Length of thread	
			W	P	P	D	G	G	B	L ₂
(mm)	(Inch)	3000 & 6000	3000	6000	3000	6000	3000	6000	B	L ₂
6	1/8	32	19	...	16	22	4.8	...	6.4	6.7
8	1/4	35	25	27	19	25	4.8	6.4	8.1	10.2
10	3/8	38	25	27	22	32	4.8	6.4	9.1	10.4
15	1/2	48	32	33	28	38	6.4	7.9	10.9	13.6
20	3/4	51	37	38	35	44	6.4	7.9	12.7	13.9
25	1	60	41	43	44	57	9.7	11.2	14.7	17.3
32	1. 1/4	67	44	46	57	64	9.7	11.2	17.0	18.0
40	1. 1/2	79	44	48	64	76	11.2	12.7	17.8	18.4
50	2	86	48	51	76	92	12.7	15.7	19.0	19.2
65	2. 1/2	92	60	64	92	108	15.7	19.0	23.6	28.9
80	3	108	65	68	108	127	19.0	22.4	25.9	30.5
100	4	121	68	75	140	159	22.4	28.4	27.7	33.0

CODES**STANDARDS AND SPECIFICATIONS****American Society of Mechanical Engineers (ASME)**

B16.5	Pipe Flanges and Flanged Fittings.
B16.9	Factory made wrought Steel Butt Weld Fittings
B16.11	Forged Steel Fittings, Socket Welding & Threaded
B16.20	Metallic Gaskets for Pipe Flanges, Ring Joint, Spiral Wound and Jacketed
B16.21	Non Metallic Flat Gaskets for Pipe Fittings
B16.36	Orifice Flanges
B16.47	Large Diameter Steel Flanges

American Society for Testing and Materials (ASTM)

A 53 / A 53M	For Pipe - Steel, Black and hot dipped, Zinc Coated, Welded & Seamless.
A 105 / A 105M	For Carbon Steel Forgings for Piping application.
A 106	For Seamless Carbon Steel Pipe for High Temperature Services.
A 123	For Zinc (hot-dip galvanized) coatings on Iron and Steel products.
A 182 / A 182 M	For Forged or rolled Alloy-Steel Pipe Flanges, Forged Fittings & Valves and Parts for High Temperature Services.
A 193 / A 193M	For Alloy - Steel and Stainless Steel Bolting materials for High Temperature Services.
A 194 / A 194M	For Carbon and Alloy - Steel nuts for bolts High Pressure or High Temperature Services or Both.
A 234 / A 234M	For Piping Fittings of Wrought Carbon Steel and Alloy Steel for Moderate & High temperature Services.
A 266 / A 266M	For Carbon Steel Forgings for Pressure Vessel Components.
A 307 / A 307M	For Carbon Steel Bolts and Studs, 60000 Psi, Tensile Strength.
A 320 / A 320M	For Alloy Steel Bolting Materials for Low Temperature Services.
A 325 / A 325M	For Structural Bolts, Steel, heat-treated, 120/105 ksi minimum Tensile Strength.
A 333 / A 333M	For Seamless & Welded Steel Pipe for Low Temperature Services.
A 335 / A 335M	For Seamless Ferritic Alloy - Steel Pipe for High Temperature Services.
A 350 / A 350M	For Carbon and low Alloy - Steel Forgings, requiring notch toughness testing for Piping Components.
A 403 / A 403M	For Wrought austenitic Stainless Steel Piping Fittings
A 420 / A 420M	For Piping Fittings of wrought Carbon Steel & Alloy - Steel for Low Temperature Services.
A 515 / A 515M	For Pressure Vessel Plates, Carbon Steel for intermediate and Higher Temperature Services.
A 516 / A 516M	For Pressure Vessel Plates, Carbon Steel for Moderate and Lower Temperature Services.
A 694 / A 694M	For Carbon & Alloy Steel Forgings For Pipe Flanges, Fittings Valves & Parts for High Pressure transmission Service

(A - Prefix), 105 - Sequential Number. M means that this specifications contains metric unit. 10 - the year of latest version.

National Association of Corrosion Engineers (NACE)

MR 0175 - (03)	Metals for Sulfide Stress Cracking and Stress Corrosion Cracking resistance in sour Oil field environments.
----------------	---

American Water Works Association (AWWA)

C207 - 01	Steel Pipe Flanges for Water Works Services - Size 4" - 144" (100 - 3600 mm)
-----------	--