



Technical Information

PIPE END PREPARATION	I-2
ROLL GROOVING DIMENSIONS FOR ANSI, BS & AS PIPE	I-3
ROLL GROOVING DIMENSIONS FOR ISO PIPE	I-4
ROLL GROOVING DIMENSIONS FOR KS & JIS PIPE	I-5
CUT GROOVING DIMENSIONS FOR IPS, BS, AS, ISO, JIS & KS PIPE	I-6

TYPICAL APPLICATIONS

FLEXIBLE COUPLINGS GENERAL SYSTEMS	I-7-8
ANCHORING, HANGING AND SUPPORTS	I-9-11
GASKET SELECTION GUIDE	I-12-13
GENERAL GASKET SERVICE RECOMMENDATIONS	I-14-16
FIRE PROTECTION SERVICES	I-17
APPROVED PRESSURE RATINGS BY UL & FM	I-18-19
LISTED PRESSURE RATINGS BY IAPMO	I-20-21
FLEXIBLE COUPLINGS SPRINKLER SYSTEMS (NFPA 13)	I-22-24

section I



integrated
piping systems

Shurjoint grooved piping systems require the processing of a roll or cut groove to the pipe ends being connected. The engagement of the housing keys in the grooves is integral in providing a secure and leak-tight joint. It is essential that the grooves are properly processed for optimum joint performance.

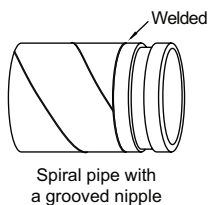
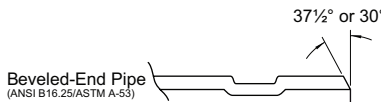
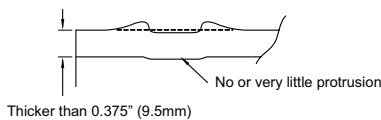
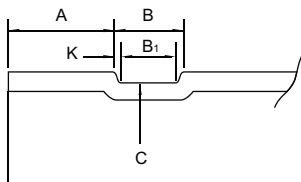
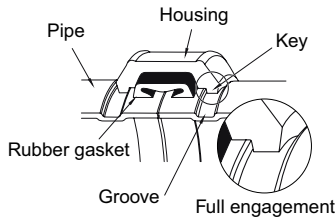

NOMINAL PIPE SIZE

Shurjoint couplings and fittings are identified by the nominal IPS pipe size in inches or nominal diameter of pipe (DN) in millimeters. Always check the actual O.D. of the pipe and fittings to be connected, as in some markets it is customary to refer to different O.D. pipes with the same nominal size.

ROLL GROOVE PROFILE

Roll grooves should be as defined as possible. To achieve optimum joint performance the "K" dimension should be as small as possible. When processing a roll groove the machine operator should manage the feed pressure of the upper roll set so as to achieve the best possible groove profile.

APPLICABLE PIPE WALL THICKNESS

Roll grooves are generally applicable to .375"/9.5 mm thick or thinner wall carbon steel pipe, stainless steel pipe, copper tube and aluminum pipe depending on the type of roll-grooving machine and roll set being used. Different wall thicknesses and sizes require the use of different roll sets. Contact the roll groove machine manufacturer for additional information.

HEAVY WALL PIPE

When you attempt to roll-groove pipe thicker than .375"/9.5mm, the metal may deform and heap up on both sides of the groove rather than radially deforming and protruding on the inside of the pipe. The extra heaped metal could lead to joint failure. In such a case, you should grind off any such extra metal to achieve a flat and smooth sealing surface. A proper rust preventative coating must be applied on the ground surface. Shurjoint strongly recommends the processing of cut-grooves on heavy or thick wall pipe.

PLAIN END PIPE AND BEVELED END PIPE

While plain-end pipe is preferred, the use of beveled end pipe is acceptable providing that the wall thickness is .375"/9.5 mm or thinner and the bevel is 37 1/2 ±2-1/2° or 30° as specified in ANSI B16.25 and ASTM A-53 respectively.

ERW PIPE

ERW pipe is one of the most popular types of pipe used today. Depending on the individual pipe and manufacturer, welding beads may remain on the surface (inside and outside) of the pipe. Always remove harmful weld beads near the pipe ends as they can cause rattling of the roll grooving machine resulting in inaccurate grooves.

GALVANIZED PIPE

Galvanized pipe is acceptable as long as the gasket seating surface is smooth and free from scale and imperfections that could affect gasket sealing. Whenever you remove welding beads or projections from the sealing surface of galvanized pipe, use caution so as to not over-grind the surface. After grinding, always apply a proper rust-prevention coating to this area.

SPIRAL WELDED PIPE

Spiral welded pipe may be used as long as the weld beads are removed from the gasket seating surface. It is also acceptable and recommended to weld a grooved end nipple to the pipe end as shown below. Whenever you remove weld beads or projections from the gasket seating surface, use caution so as to not over-grind the surface. After grinding, always apply a proper rust-prevention coating to this area.

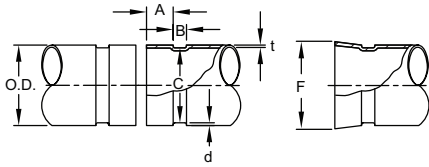

Basic roll groove dimensions conform to ANSI/AWWA C606-06 Table 5 with slightly adjusted tolerances to incorporate international standards including CSA B242, ISO/FDIS 6152-12, VdS 2100-6en and JPF MP-006.

ROLL GROOVING DIMENSIONS ANSI B36.10, BS 1387 (M) & AS-1074 (M) PIPE

NOMINAL SIZE	PIPE O.D.		A ±0.030 ±0.76	B ±0.030 ±0.76	C +0.000 +0.00	MIN. WALL T	D GROOVE DEPTH D (REF.)	F MAX. ALLOWED FLARE DIA.	
	BASIC	TOLERANCE							
in mm	in mm	in mm	in mm	in mm	in mm	in mm	in mm	in mm	
3/4	1.050	+0.010	-0.010	0.625	0.281	0.938-0.015	0.065	0.056	1.15
20	26.7	+0.25	-0.25	15.88	7.14	23.83-0.38	1.65	1.42	29.21
1	1.315	+0.013	-0.013	0.625	0.281	1.190-0.015	0.065	0.063	1.43
25	33.4	+0.33	-0.33	15.88	7.14	30.23-0.38	1.65	1.60	36.30
1-1/4	1.660	+0.016	-0.016	0.625	0.281	1.535-0.015	0.065	0.063	1.77
32	42.2	+0.41	-0.41	15.88	7.14	38.99-0.38	1.65	1.60	44.96
1-1/2	1.900	+0.019	-0.019	0.625	0.281	1.775-0.015	0.065	0.063	2.01
40	48.3	+0.48	-0.48	15.88	7.14	45.09-0.38	1.65	1.60	51.05
2	2.375	+0.024	-0.024	0.625	0.344	2.250-0.015	0.065	0.063	2.48
50	60.3	+0.61	-0.61	15.88	8.74	57.15-0.38	1.65	1.60	62.99
2-1/2	2.875	+0.029	-0.029	0.625	0.344	2.720-0.018	0.083	0.078	2.98
65	73.0	+0.74	-0.74	15.88	8.74	69.09-0.46	2.11	1.98	75.69
76.1 mm	3.000	+0.030	-0.030	0.625	0.344	2.844-0.018	0.090	0.075	3.10
	76.1	+0.76	-0.76	15.88	8.74	72.24-0.46	2.30	1.93	78.74
3	3.500	+0.035	-0.031	0.625	0.344	3.344-0.018	0.083	0.078	3.60
80	88.9	+0.89	-0.79	15.88	8.74	84.94-0.46	2.11	1.98	91.44
101.6 mm	4.000	+0.040	-0.031	0.625	0.344	3.834-0.020	0.083	0.083	4.10
	101.6	+1.02	-0.79	15.88	8.74	97.38-0.51	2.11	2.11	104.10
108.0 mm	4.250	+0.042	-0.031	0.625	0.344	4.084-0.020	0.083	0.083	4.35
	108.0	+1.07	-0.79	15.88	8.74	103.73-0.51	2.11	2.11	110.49
4	4.500	+0.040	-0.031	0.625	0.344	4.334-0.020	0.083	0.083	4.60
100	114.3	+1.02	-0.79	15.88	8.74	110.08-0.51	2.11	2.11	116.84
133.0 mm	5.250	+0.051	-0.031	0.625	0.344	5.084-0.020	0.109	0.083	5.35
	133.0	+1.32	-0.79	15.88	8.74	129.13-0.51	2.77	2.11	135.89
139.7 mm	5.500	+0.050	-0.031	0.625	0.344	5.333-0.020	0.109	0.083	5.60
	139.7	+1.40	-0.79	15.88	8.74	135.46-0.51	2.77	2.11	142.24
5	5.563	+0.056	-0.031	0.625	0.344	5.395-0.022	0.109	0.083	5.66
125	141.3	+1.42	-0.79	15.88	8.74	137.03-0.56	2.77	2.11	143.76
159.0 mm	6.250	+0.063	-0.031	0.625	0.344	6.084-0.030	0.109	0.083	6.35
	159.0	+1.60	-0.79	15.88	8.74	154.53-0.76	2.77	2.11	161.29
165.1 mm	6.500	+0.063	-0.031	0.625	0.344	6.334-0.022	0.109	0.085	6.60
	165.1	+1.60	-0.79	15.88	8.74	160.88-0.56	2.77	2.16	167.64
6	6.625	+0.063	-0.031	0.625	0.344	6.455-0.022	0.109	0.085	6.73
150	168.3	+1.60	-0.79	15.88	8.74	163.96-0.56	2.77	2.16	170.94
216.3 mm	8.516	+0.063	-0.031	0.750	0.469	8.331-0.025	0.109	0.092	8.69
	216.3	+1.60	-0.79	19.05	11.91	211.61-0.64	2.77	2.34	220.73
8	8.625	+0.063	-0.031	0.750	0.469	8.441-0.025	0.109	0.092	8.80
200	219.1	+1.60	-0.79	19.05	11.91	214.40-0.64	2.77	2.34	223.52
10	10.750	+0.063	-0.031	0.750	0.469	10.562-0.027	0.134	0.094	10.92
250	273.0	+1.60	-0.79	19.05	11.91	268.27-0.69	3.40	2.39	277.37
12	12.750	+0.063	-0.031	0.750	0.469	12.531-0.030	0.156	0.109	12.92
300	323.9	+1.60	-0.79	19.05	11.91	318.29-0.76	3.96	2.77	328.17
14	14.000	+0.063	-0.031	0.938	0.469	13.781-0.030	0.156	0.109	14.10
350	355.6	+1.60	-0.79	23.83	11.91	350.04-0.76	3.96	2.77	358.14
16	16.000	+0.063	-0.031	0.938	0.469	15.781-0.030	0.165	0.109	16.10
400	406.4	+1.60	-0.79	23.83	11.91	400.84-0.76	4.19	2.77	408.94
18	18.000	+0.063	-0.031	1.000	0.469	17.781-0.030	0.165	0.109	18.16
450	457.2	+1.60	-0.79	25.40	11.91	451.64-0.76	4.19	2.77	461.26
20	20.000	+0.063	-0.031	1.000	0.469	19.781-0.030	0.188	0.109	20.16
500	508.0	+1.60	-0.79	25.40	11.91	502.44-0.76	4.78	2.77	512.06
22	22.000	+0.063	-0.031	1.000	0.469	21.656-0.030	0.188	0.172	22.20
550	558.8	+1.60	-0.79	25.40	11.91	550.06-0.76	4.78	4.37	563.88
24	24.000	+0.063	-0.031	1.000	0.500	23.656-0.030	0.218	0.172	24.20
600	609.6	+1.60	-0.79	25.40	12.70	600.86-0.76	5.54	4.37	614.68

- Pipe O.D.: Maximum allowable tolerances from square cut ends is 0.03" for sizes up to 3-1/2"; 0.045" for 4" thru 6"; and 0.060" for sizes 8" and above.
- The gasket seating surface "A" shall be free from deep scores, marks, or ridges that would prevent a positive seal.
- The "C" dimensions are average values. The groove must be of uniform depth around the entire circumference. Use a Shurjoint groove gage or rule to check the groove diameter.
- The "t" is the minimum allowable wall thickness that may be roll-grooved.
- The "d" is for reference use only. The groove depth shall be determined by the groove diameter "C".
- Flare Diameter: The pipe end that may flare when the groove is rolled shall be within this limit when measured at the extreme end of the pipe.

For ISO 4200:1991 Plain-end Steel Tubes, Welded and Seamless (Superseding BS1387 and DIN 2440 & DIN 2448)

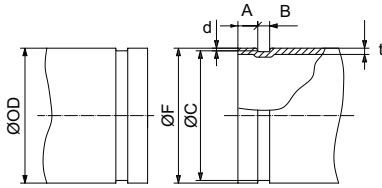

ROLL GROOVING DIMENSIONS PER ISO/FDIS 6182-12 TABLE 1

PIPE OR TUBE			DIMENSIONAL SPECIFICATIONS						
NOMINAL SIZE	OUTSIDE DIAMETER (O.D.)		GASKET SEAT A 30.76	GASKET WIDTH B 30.76	GROOVED DIAMETER C		GROOVE DEPTH D	WALL THICK- NESS T MIN. ALLOW.	FLARE F MAX. DIA.
	ACTUAL SIZE	TOLERANCE			ACTUAL SIZE	TOLERANCE			
25	33,7	+0,41 / -0,68	15,88	7,14	30,23	0 / -0,38	1,70	1,8	34,5
32	42,4	+0,50 / -0,60	15,88	7,14	38,99	0 / -0,38	1,70	1,8	43,3
40	48,3	+0,44 / -0,52	15,88	7,14	45,09	0 / -0,38	1,60	1,8	49,4
50	60,3	±0,61	15,88	8,74	57,15	0 / -0,38	1,60	1,8	62,2
65	73,0	±0,74	15,88	8,74	69,09	0 / -0,46	1,98	2,3	75,2
65	76,1	±0,76	15,88	8,74	72,26	0 / -0,46	1,93	2,3	77,7
80	88,9	+0,89 / -0,79	15,88	8,74	84,94	0 / -0,46	1,98	2,3	90,6
90	101,6	+1,02 / -0,79	15,88	8,74	97,38	0 / -0,51	2,11	2,3	103,4
100	108,0	+1,07 / -0,79	15,88	8,74	103,73	0 / -0,51	2,11	2,3	109,7
100	114,3	+1,14 / -0,79	15,88	8,74	110,08	0 / -0,51	2,11	2,3	116,2
125	133,9	+1,32 / -0,79	15,88	8,74	129,13	0 / -0,51	1,93	2,9	134,9
125	139,7	+1,40 / -0,79	15,88	8,74	135,48	0 / -0,56	2,11	2,9	141,7
125	141,3	+1,42 / -0,79	15,88	8,74	137,03	0 / -0,56	2,13	2,9	143,5
150	159,0	+1,60 / -0,79	15,88	8,74	154,50	0 / -0,56	2,20	2,9	161,0
150	165,1	+1,60 / -0,79	15,88	8,74	160,90	0 / -0,56	2,16	2,9	167,1
150	168,3	+1,60 / -0,79	15,88	8,74	163,96	0 / -0,56	2,16	2,9	170,7
200	219,1	+1,60 / -0,79	19,05	11,91	214,40	0 / -0,64	2,34	2,9	221,5
250	277,4	+1,60 / -0,79	19,05	11,91	268,28	0 / -0,69	2,39	3,6	275,4
300	328,2	+1,60 / -0,79	19,05	11,91	318,29	0 / -0,76	2,77	4,0	326,2

1. Pipe O.D.: Maximum allowable tolerances from square cut ends is 0.03" for sizes up to 3-1/2"; 0.045" for 4" thru 6"; and 0.060" for sizes 8" and above.
2. The gasket seating surface "A" shall be free from deep scores, marks, or ridges that would prevent a positive seal.
3. The "C" dimensions are average values. The groove must be of uniform depth around the entire circumference. Use a Shurjoint groove gage or rule to check the groove diameter.
4. The "t" is the minimum allowable wall thickness that may be roll-grooved.
5. The "d" is for reference use only. The groove depth shall be determined by the groove diameter "C".
6. Flare Diameter: The pipe end that may flare when the groove is rolled shall be within this limit when measured at the extreme end of the pipe.

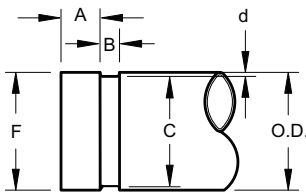

ROLL GROOVING DIMENSIONS KS D3507 & JIS G3452 CARBON STEEL PIPE

NOMINAL SIZE		PIPE O.D.	GASKET SEAT A +0.76*	GROOVE WIDTH B +0.76*	GROOVE DIA. C		GROOVE DEPTH D (REF)	MAX. ALLOWED FLARE DIA. F
A	B				BASIC	TOLERANCE +0.00*		
mm	in	mm	mm	mm	mm	mm	mm	mm
25A	1	34.0	16.0	7.1	30.4	-0.38	1.80	35.5
32A	1-1/4	42.7	16.0	7.1	39.1	-0.38	1.80	44.2
40A	1-1/2	48.6	16.0	7.1	45.0	-0.38	1.80	50.1
50A	2	60.5	16.0	8.7	56.9	-0.38	1.80	62.0
65A	2-1/2	76.3	16.0	8.7	72.2	-0.46	2.05	77.8
80A	3	89.1	16.0	8.7	84.9	-0.46	2.10	90.6
100A	4	114.3	16.0	8.7	110.1	-0.51	2.10	116.8
125A	5	139.8	16.0	8.7	135.5	-0.56	2.15	142.3
150A	6	165.2	16.0	8.7	160.8	-0.56	2.20	167.7
200A	8	216.3	19.0	11.9	211.6	-0.64	2.35	219.8
250A	10	267.4	19.0	11.9	262.6	-0.69	2.40	270.9
300A	12	318.5	19.0	11.9	312.9	-0.76	2.80	322.0

- * The tolerance for the JIS & KS pipe has a little difference.
- 1. Pipe O.D.: Maximum allowable tolerances from square cut ends is 0.03" for sizes up to 3-1/2"; 0.045" for 4" thru 6"; and 0.060" for sizes 8" and above.
- 2. The gasket seating surface "A" shall be free from deep scores, marks, or ridges that would prevent a positive seal.
- 3. The "C" dimensions are average values. The groove must be of uniform depth around the entire circumference. Use a Shurjoint groove gage or rule to check the groove diameter.
- 4. The "t" is the minimum allowable wall thickness that may be roll-grooved.
- 5. The "d" is for reference use only. The groove depth shall be determined by the groove diameter "C".
- 6. Flare Diameter: The pipe end that may flare when the groove is rolled shall be within this limit when measured at the extreme end of the pipe.

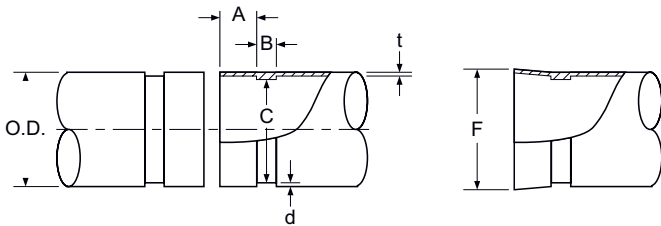

ROLL GROOVING DIMENSIONS KS D3507 & JIS G3452 CARBON STEEL PIPE

NOMINAL SIZE	PIPE O.D.		A ±0.03 ±0.8	B ±0.03 ±0.8	C +0, -0.063 +0, -1.6	D GROOVE DEPTH (REF)	T MIN WALL	F MAX. ALLOWED FLARE DIA.
	BASIC	TOLERANCE						
in	in	in	in	in	in	in	in	in
mm	mm	mm	mm	mm	mm	mm	mm	mm
26	26.0	+0.093	-0.031	1.75	0.625	25.5	0.25	26.2
650	660.4	+2.36	-0.79	44.5	15.9	647.7	6.4	665.5
28	28.0	+0.093	-0.031	1.75	0.625	27.5	0.25	28.2
700	711.2	+2.36	-0.79	44.5	15.9	698.5	6.4	716.3
30	30.0	+0.093	-0.031	1.75	0.625	29.5	0.25	30.2
750	762.0	+2.36	-0.79	44.5	15.9	749.3	6.4	767.1
32	32.0	+0.093	-0.031	1.75	0.625	31.5	0.25	32.2
800	812.8	+2.36	-0.79	44.5	15.9	800.1	6.4	817.9
36	36.0	+0.093	-0.031	1.75	0.625	35.5	0.25	36.2
900	914.4	+2.36	-0.79	44.5	15.9	901.7	6.4	919.5
40	40.0	+0.093	-0.031	2.00	0.625	39.5	0.25	40.4
1000	1016.0	+2.36	-0.79	50.8	15.9	1003.3	6.4	1026.2
42	42.0	+0.093	-0.031	2.00	0.625	41.5	0.25	42.2
1050	1066.8	+2.36	-0.79	50.8	15.9	1054.1	6.4	1071.9

- 1. Square cut: Max. allowable tolerances from square cut are 0.060" (1.6 mm).
- 2. The gasket seating surface "A" shall be free from deep scores, marks, or ridges that would prevent a positive seal.
- 3. The "C" dimensions are average values. The groove must be of uniform depth around the entire circumference. Use a Shurjoint groove gage or rule to check the groove diameter.
- 4. The "t" is the minimum allowable wall thickness that may be roll-grooved.
- 5. The "d" is for reference use only. The groove depth shall be determined by the groove diameter "C".
- 6. Flare Diameter: The pipe end that may flare when the groove is rolled shall be within this limit when measured at the extreme end of the pipe.

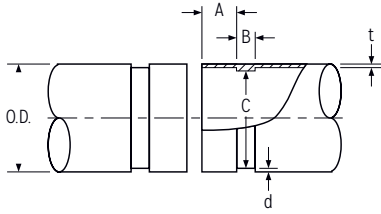

CUT GROOVING DIMENSIONS IPS, BS, AS, ISO, JIS & KS PIPE

NOMINAL SIZE	PIPE O.D.			A ±0.031 ±0.79	B ±0.031 ±0.79	C +0.000 +0.00	T MIN. WALL	D GROOVE DEPTH (REF.)
	BASIC	TOLERANCE						
in mm	in mm	in mm	in mm	in mm	in mm	in mm	in mm	in mm
3/4	1.050	+0.010	-0.010	0.625	0.313	0.938-0.015	0.113	0.056
20	26.7	+0.25	-0.25	15.88	7.95	23.83-0.38	2.87	1.42
1	1.315	+0.013	-0.013	0.625	0.313	1.190-0.015	0.133	0.063
25	33.4	+0.33	-0.33	15.88	7.95	30.23-0.38	3.38	1.60
1-1/4	1.660	+0.016	-0.016	0.625	0.313	1.535-0.015	0.140	0.063
32	42.2	+0.41	-0.41	15.88	7.95	38.99-0.38	3.56	1.60
1-1/2	1.900	+0.019	-0.019	0.625	0.313	1.775-0.015	0.145	0.063
40	48.3	+0.48	-0.48	15.88	7.95	45.09-0.38	3.68	1.60
2	2.375	+0.024	-0.024	0.625	0.313	2.250-0.015	0.154	0.063
50	60.3	+0.61	-0.61	15.88	7.95	57.15-0.38	3.91	1.60
2-1/2	2.875	+0.029	-0.029	0.625	0.313	2.720-0.018	0.188	0.078
65	73.0	+0.74	-0.74	15.88	7.95	69.09-0.46	4.78	1.98
76.1 mm	3.000	+0.030	-0.030	0.625	0.313	2.845-0.018	0.188	0.078
	76.1	+0.76	-0.76	15.88	7.95	72.26-0.46	4.78	1.98
3	3.500	+0.035	-0.031	0.625	0.313	3.344-0.018	0.188	0.078
80	88.9	+0.89	-0.79	15.88	7.95	84.94-0.46	4.78	1.98
101.6 mm	4.000	+0.040	-0.031	0.625	0.313	3.834-0.020	0.188	0.078
	101.6	+1.02	-0.79	15.88	7.95	97.38-0.51	4.78	1.98
101.6 mm	4.000	+0.040	-0.031	0.625	0.313	3.834-0.020	0.188	0.078
	101.6	+1.02	-0.79	15.88	7.95	97.38-0.51	4.78	1.98
4	4.250	+0.043	-0.031	0.625	0.375	4.084-0.020	0.203	0.083
100	108.0	+1.04	-0.79	15.88	9.53	103.73-0.51	5.16	2.11
4	4.500	+0.045	-0.031	0.625	0.375	4.334-0.020	0.203	0.083
100	114.3	+1.14	-0.79	15.88	9.53	110.08-0.51	5.16	2.11
133.0 mm	5.250	+0.053	-0.031	0.625	0.375	5.084-0.020	0.203	0.076
	133.0	+1.70	-0.79	15.88	9.53	129.13-0.51	5.16	1.93
139.7 mm	5.500	+0.056	-0.031	0.625	0.375	5.334-0.020	0.203	0.083
	139.7	+1.42	-0.79	15.88	9.53	135.48-0.51	5.16	2.11
5	5.563	+0.056	-0.031	0.625	0.375	5.395-0.022	0.203	0.083
125	141.3	+1.42	-0.79	15.88	9.53	137.03-0.56	5.16	2.11
159.0 mm	6.250	+0.063	-0.031	0.625	0.375	6.080-0.030	0.219	0.087
	159.0	+1.60	-0.79	15.88	9.53	154.43-0.76	5.56	2.20
165.1 mm	6.500	+0.065	-0.031	0.625	0.375	6.335-0.022	0.203	0.085
	165.1	+1.57	-0.79	15.88	9.53	160.90-0.56	5.16	2.16
6	6.625	+0.063	-0.031	0.625	0.375	6.455-0.022	0.219	0.085
150	168.3	+1.60	-0.79	15.88	9.53	163.96-0.56	5.56	2.16
8	8.625	+0.063	-0.031	0.750	0.438	8.441-0.025	0.238	0.092
200	219.1	+1.60	-0.79	19.05	11.13	214.40-0.64	6.05	2.34
10	10.750	+0.063	-0.031	0.750	0.500	10.562-0.027	0.250	0.094
250	273.0	+1.60	-0.79	19.05	12.70	268.27-0.69	6.35	2.39
12	12.750	+0.063	-0.031	0.750	0.500	12.531-0.030	0.279	0.109
300	323.9	+1.60	-0.79	19.05	12.70	318.29-0.76	7.09	2.77
200 JIS	8.516	+0.063	-0.031	0.750	0.438	8.331-0.025	0.238	0.092
	216.3	+1.60	-0.79	19.05	11.13	211.60-0.64	6.05	2.34
250 JIS	10.528	+0.063	-0.031	0.750	0.500	10.339-0.027	0.250	0.094
	267.4	+1.60	-0.79	19.05	12.70	262.60-0.69	6.35	2.39
300 JIS	12.539	+0.063	-0.031	0.750	0.500	12.319-0.030	0.279	0.109
	318.5	+1.60	-0.79	19.05	12.70	312.90-0.76	7.09	2.77
14	14.000	+0.063	-0.031	0.938	0.500	13.781-0.030	0.281	0.109
350	355.6	+1.60	-0.79	23.83	12.70	350.04-0.76	7.14	2.77
16	16.000	+0.063	-0.031	0.938	0.500	15.781-0.030	0.312	0.109
400	406.4	+1.60	-0.79	23.83	12.70	400.84-0.76	7.92	2.77
18	18.000	+0.063	-0.031	1.000	0.500	17.781-0.030	0.312	0.109
450	457.2	+1.60	-0.79	25.40	12.70	451.64-0.76	7.92	2.77
20	20.000	+0.063	-0.031	1.000	0.500	19.781-0.030	0.312	0.109
500	508.0	+1.60	-0.79	25.40	12.70	502.44-0.76	7.92	2.77
22	22.000	+0.063	-0.031	1.000	0.563	21.656-0.030	0.375	0.172
550	558.8	+1.60	-0.79	25.40	14.30	550.06-0.76	9.53	4.37
24	24.000	+0.063	-0.031	1.000	0.563	23.656-0.030	0.375	0.172
600	609.6	+1.60	-0.79	25.40	14.30	600.86-0.76	9.53	4.37

1. Pipe OD: Maximum allowable tolerances from square of ends is 0.03" for sizes up to 3-1/2"; 0.045" for 4" thru 6", and 0.060" for sizes 8" and above.
 2. Gasket Seating Surface: The gasket seating surface shall be free from deep scores, marks, or ridges that would prevent a positive seal.
 3. Groove Width: Groove width is to be measured between vertical flanks of the groove side walls.
 4. Groove Diameter: The "C" diameters are average values. The groove must be of uniform depth around the entire pipe circumference.
 5. Minimum Wall Thickness: The "t" is the minimum allowable wall thickness that may be cut-grooved.
 6. Groove Depth: The "d" is for reference use only. The groove dimension shall be determined by the groove diameter "C".

1. ABSORPTION OF VIBRATION AND NOISE

When a pump operates with frequent starts and stops, the piping system is affected by the noise and vibration of the equipment. The entire system may develop a large sway, referred to as sympathetic vibration, as a result of the frequent cycling. Shurjoint flexible couplings will help reduce such vibration and noise. The system should always be properly designed with steel angle sway braces to protect the system from large sways.

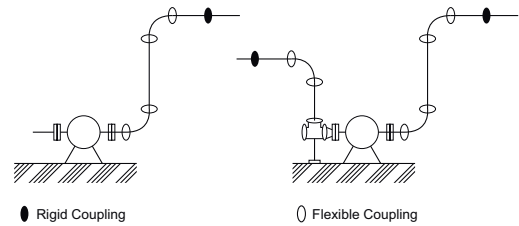

2. ADJUSTMENT OF MISALIGNMENT

When a straight run has need for a slight adjustment of alignment on the jobsite as shown in the diagram, you can accomplish this with the use of two flexible couplings. The following table shows the deflection value (δ) of the Shurjoint 7705 flexible couplings.

AMOUNT OF DEFLECTION (δ)

NOMINAL SIZE	DEFLECTION ANGLE(θ)	DISTANCE BETWEEN COUPLINGS (L) MM				
		600	1200	1500	2000	3000
2" / 50	3° 02'	32	64	79	106	159
2-1/2" / 65	2° 30'	26	52	65	87	131
3" / 80	2° 04'	22	43	54	72	108
4" / 100	3° 12'	34	67	84	112	168
5" / 125	2° 36'	27	54	68	91	136
6" / 150	1° 10'	12	24	31	41	61
8" / 200	1° 40'	17	35	44	58	87
10" / 250	1° 20'	14	28	35	47	70
12" / 300	1° 08'	12	24	30	40	59

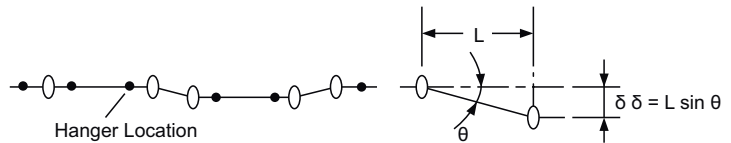

3. ABSORPTION OF DISTORTION

With the use of an assembly as shown below, ground sinking or movement around a tank or reservoir can be effectively absorbed, avoiding damage to the tank, reservoir and or the piping system.

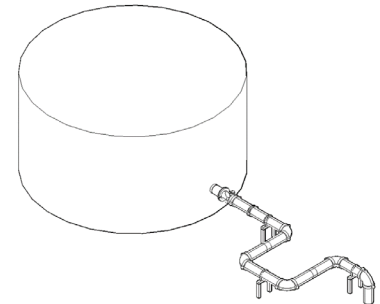

4. ABSORPTION OF INTER-FLOOR DEFLECTION

Risers of high-rise flexible structure buildings are subjected to lateral sways (inter-floor deflection) when an earthquake occurs. If we assume the inter-floor deflection is 1/150 and the floor height (H) as 4 meters, the estimated inter-floor deflection (α) will be:

$$\alpha = H \times 1/150 = 4000 \times 1/150 = 27 \text{ mm}$$

If we use a 200 mm (8") 7707 coupling for each floor, the maximum deflection (β) that each coupling can accommodate will be:

$$\beta = L \times \tan \theta = 4000 \times 0.02915 = 4.56" = 116 \text{ mm } (\theta = 1.67^\circ)$$

The example shows a flexible coupling would be sufficient to absorb this scale of seismic sways.

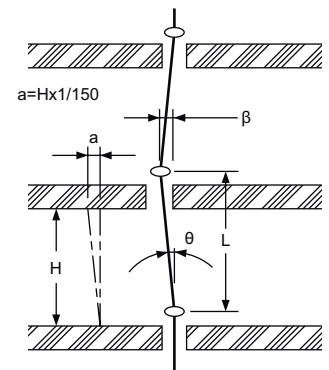

5. ABSORPTION OF MISALIGNMENT

As shown in the diagram, each branch connection to the free riser will be subjected to serious shearing forces as pressure thrusts or thermal movement increases. By using two flexible couplings, you can solve this problem.

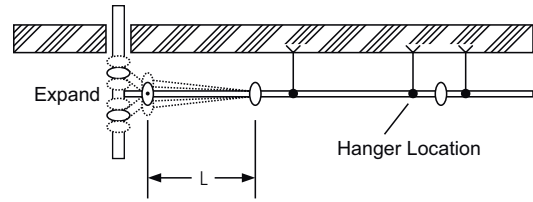

6. CURVED LAYOUT

With Shurjoint flexible couplings you can design a slowly curved layout for a system along a curved tunnel, winding road or curved building.

$R = \frac{L}{2 \tan \theta/2}$ (where: R is radius of curvature, L is pipe length, and θ is max. allowed deflection of a coupling)

Example: When using model 7705 100 mm (4") couplings for the layout as shown in the diagram, the max. allowed deflection (θ) of the coupling is 3.4°, and the pipe length (L) is 5.5 meters, the radius of curvature (R) will be 92.7 meters.

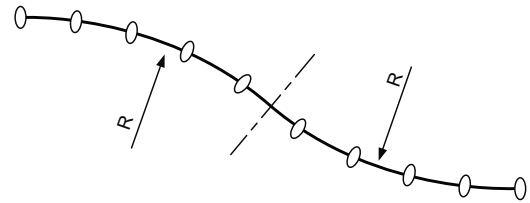

7. ABSORPTION OF THERMAL STRESS

Thermal stress is caused by changes in temperature, resulting in either expansion or contraction. With the use of Shurjoint flexible couplings you can design your system to accommodate such movement without the need for costly expansion joints.

The thermal expansion or contraction (μ) is determined by the length of pipe (L) and temperature difference (ΔT).
 $\mu = \alpha \times L \times \Delta T$

As the linear expansion coefficient for steel (α) is 1.2×10^{-5} , you can use the table to the right to determine the thermal expansion.

Example:

- Pipe size: 100 mm (4")
- Max. pipe end separation (E) : 3.2 mm
- Pipe length (L) : 5500 mm
- Temperature difference (ΔT) : 40° C (+5° C to +45° C)
- $\alpha = 1.2 \times 10^{-5} / ^\circ \text{C}$

$$\mu = \alpha \times L \times \Delta T = 1.2 \times 10^{-5} / ^\circ \text{C} \times 5500 \text{ mm} \times 40^\circ \text{C} = 2.64 \text{ mm}$$

The thermal expansion of a 5.5 meter standard length of pipe (μ) is within the allowance (= max. pipe end separation) of a flexible coupling. In other words, if you use a coupling for each pipe length of 5.5 meters, the coupling will accommodate the thermal expansion or contraction expected to take place for a 40° C temperature change. When you calculate the necessary number of couplings (N) for an anchored system, you should place a clearance of $N \times E \times 1/2$ as a safety factor.

Whether it is thermal expansion, contraction, or a combination thereof, the system requires suitable anchor installations with properly space alignment guides and weight support devices. Where and when larger thermal movement is anticipated, you should use supplementary expansion joint(s).

THERMAL EXPANSION

METRIC

TEMPERATURE DIFFERENCE ΔT (°C)	PIPE LENGTH L (M)					
	1	5.5*	10	20	30	40
1	0.012	0.07	0.12	0.24	0.36	0.48
5	0.06	0.33	0.6	1.2	1.8	2.4
10	0.12	0.66	1.2	2.4	3.6	4.8
20	0.24	1.3	2.4	4.8	7.2	9.6
30	0.36	2	3.6	7.2	11	15
40	0.48	2.6	4.8	9.6	14	20
50	0.6	3.3	6	12	18	24
60	0.72	4	7.2	14	22	29
70	0.84	4.6	8.4	17	25	34
80	0.96	5.3	9.6	19	29	39

* 5.5 meters is the standard length of commercial carbon steel pipe.

THERMAL EXPANSION

STANDARD

TEMPERATURE (°F)	PIPE LENGTH L (FT)			
	20	40	60	100
0	-0.10	-0.20	-0.29	-0.49
25	-0.06	-0.13	-0.19	-0.32
50	-0.03	-0.06	-0.08	-0.14
70	0	0	0	0
100	0.05	0.09	0.14	0.23
125	0.08	0.17	0.25	0.42
150	0.12	0.24	0.37	0.61
175	0.16	0.32	0.48	0.80
200	0.20	0.40	0.59	0.99
225	0.24	0.48	0.73	1.21

* Coefficient of thermal expansion of steel pipe = 6.33 in/in, °F x 10⁻⁶

Shurjoint grooved couplings are designed to hold axial thrusts 4-5 times their rated working pressure, though the strength against bending movements is less than that of steel pipe. The joint may be damaged when a bending movement greater than the allowed deflection occurs. System designers should provide anchors (main and intermediate) and pipe guides with proper spacing to protect the system from unexpected large bending movements.

These illustrations are examples only, and are not intended to be used for all installations as conditions and requirements vary from job to job. Reliance on general data or information contained herein shall be at the user's sole risk and without obligation to Shurjoint. Hangers shall be designed to support five times the weight of water-filled pipe plus 250 lb (115 kgs) at each point of pipe support (NFPA 13 9.1.1.1.). The following illustrations are examples of acceptable hanger types and sizes per NFPA 13.

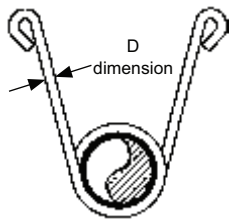

Wraparound U-hook

U-HOOK SIZES

PIPE SIZE	DIMENSION	
	D	
in	in	mm
≤ 2	5/16	7.9
2-1/2 - 6	3/8	9.5
8	1/2	12.7



Adjustable swivel Ring - rod tight to pipe

ROD SIZES

PIPE SIZE	DIMENSION	
	D	
in	in	mm
≤ 4	3/8	9.5
5 - 8	1/2	12.7
10 - 12	5/8	15.9

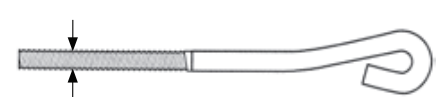

EYE ROD SIZES

PIPE SIZE	DIMENSION	
	D	
in	in	mm
≤ 4	3/8	9.5
5 - 6	1/2	12.7
10 - 12	3/4	15.1

HANGERS FOR STRAIGHT RUNS

For straight runs, you can use both flexible and rigid couplings. When rigid couplings are used, the same hanger spacing as other piping methods can be applied. You can refer to the hanger spacing standards of ANSI B31.1 Power Piping Code, B31.9 Building Services Piping Code, NFPA 13 Sprinkler Systems, or Mechanical Equipment Construction Guide (Japan). See the table to the right.

SUGGESTED MAX. SPAN BETWEEN SUPPORTS STEEL PIPE

NOMINAL PIPE SIZE	WATER SERVICE (FEET / METERS)				GAS OR AIR SERVICE (FEET / METERS)		
	1)	2)	3)	4)	1)	2)	3)
1 / 25	7 / 2.1	9 / 2.7	12 / 3.7	6.6 / 2.0	9 / 2.7	10 / 3.0	12 / 3.7
1-1/4 / 32	7 / 2.1	11 / 3.4	12 / 3.7	6.6 / 2.0	9 / 2.7	12 / 3.7	12 / 3.7
1-1/2 / 40	7 / 2.1	12 / 3.7	15 / 4.6	6.6 / 2.0	9 / 2.7	13 / 4.0	15 / 4.6
2 / 50	10 / 3.0	13 / 4.0	15 / 4.6	6.6 / 2.0	13 / 4.0	15 / 4.6	15 / 4.6
2-1/2 / 65	11 / 3.4	15 / 4.6	15 / 4.6	6.6 / 2.0	14 / 4.3	17 / 5.2	15 / 4.6
3 / 80	12 / 3.7	16 / 4.9	15 / 4.6	6.6 / 2.0	15 / 4.6	19 / 5.8	15 / 4.6
4 / 100	14 / 4.3	18 / 5.5	15 / 4.6	6.6 / 2.0	17 / 5.2	21 / 6.4	15 / 4.6
5 / 125	16 / 4.9	20 / 6.1	15 / 4.6	6.6 / 2.0	20 / 6.1	24 / 7.3	15 / 4.6
6 / 150	17 / 5.2	21 / 6.4	15 / 4.6	10 / 3.0	21 / 6.4	26 / 7.9	15 / 4.6
8 / 200	19 / 5.8	23 / 7.0	15 / 4.6	10 / 3.0	24 / 7.3	29 / 8.8	15 / 4.6
10 / 250	19 / 5.8	25 / 7.6	15 / 4.6	10 / 3.0	24 / 7.3	33 / 10.1	15 / 4.6
12 / 300	23 / 7.0	26 / 7.9	15 / 4.6	10 / 3.0	30 / 9.1	36 / 11.0	15 / 4.6
14 / 350	23 / 7.0	26 / 7.9	15 / 4.6		30 / 9.1	37 / 11.3	15 / 4.6
16 / 400	27 / 8.2	26 / 7.9	15 / 4.6		35 / 10.7	40 / 12.2	15 / 4.6
18 / 450	27 / 8.2	27 / 8.2	15 / 4.6		35 / 10.7	43 / 13.1	15 / 4.6
20 / 500	30 / 9.1	27 / 8.2	15 / 4.6		39 / 11.9	46 / 14.0	15 / 4.6
24 / 600	32 / 9.8	26 / 7.9	15 / 4.6		42 / 12.8	50 / 15.2	15 / 4.6

1. ANSI B31.1 Power Piping Code
2. ANSI B31.9 Building Services Piping Code
3. NFPA 13 Sprinkler systems
4. Ministry of Land & Transportation of Japan: Mechanical Equipment Construction Guide

HANGER LOCATIONS ON STRAIGHT RUNS WHERE FLEXIBLE COUPLINGS ARE USED

When flexible couplings are used on straight runs, location of hangers shall be designed as close to each coupling as possible, or within a distance of less than 1/6 the span.

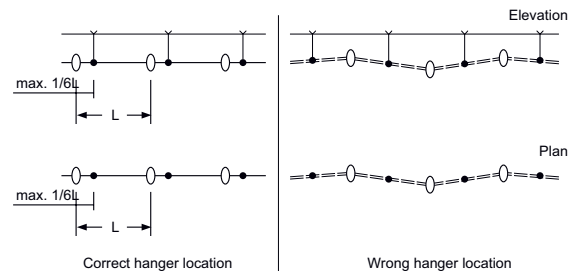

HANGER LOCATIONS ON CURVED PIPE RUNS AND BRANCH LINES

Additional hangers or supports shall be provided where runs are curved, connected to a branch line or on short risers or drops.

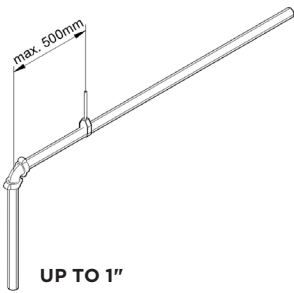

UP TO 1"

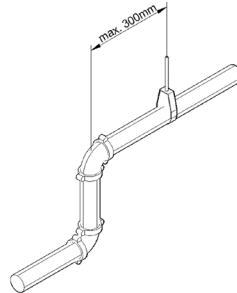

max. 300mm

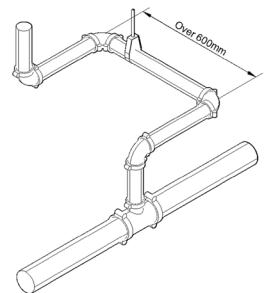

Over 600mm

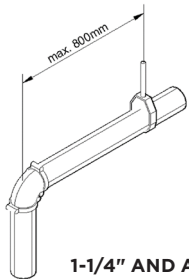

max. 800mm

1-1/4" AND ABOVE

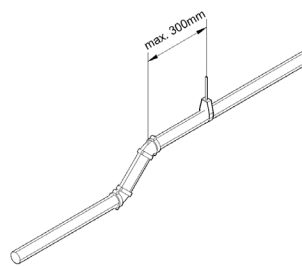

max. 300mm

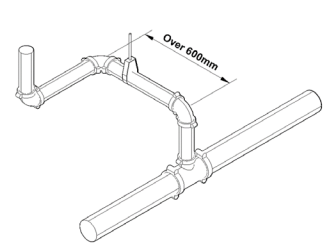

Over 600mm

CURVED PIPE RUNS

SHORT RISER (OR SHORT DROP)

BRANCH LINE

TYPICAL DESIGNS OF HANGERS AND SWAY BRACES FOR PIPE RUNS

Pipe runs shall be adequately suspended by rod hangers or steel angles that are directly attached to the building structure to restrict the movement of the piping. Hangers and their components shall be ferrous. The maximum distance between hangers shall not exceed that specified in the table of previous page.

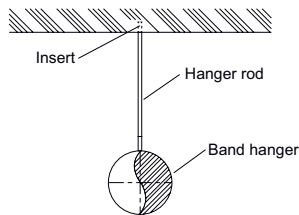

A rod hanger for a single pipe run

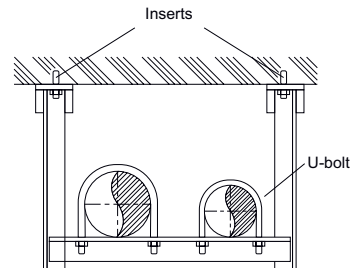

A trapeze hanger suspended from ceiling

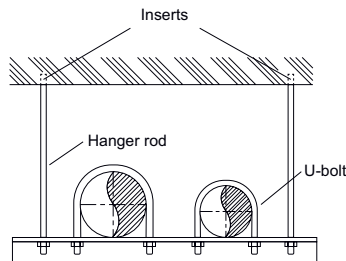

A trapeze hanger for multiple pipe runs

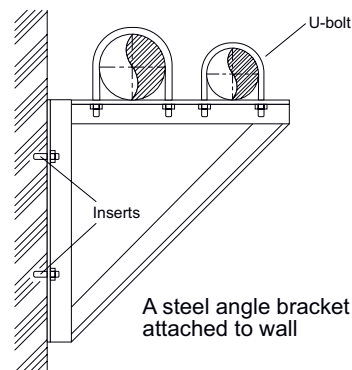

A steel angle bracket attached to wall

SUPPORTS FOR RISERS

In multi-story buildings, risers shall be fixed (or anchored) at the lowest level and at the top of the riser and shall be supported by riser clamps or U-bolts at each floor level to prevent the risers from swaying. If risers are braced by the penetration floors, the number of riser clamps or U-bolts may be reduced to one at each three stories. For risers, either flexible or rigid couplings can be used as long as proper anchoring and support is provided.

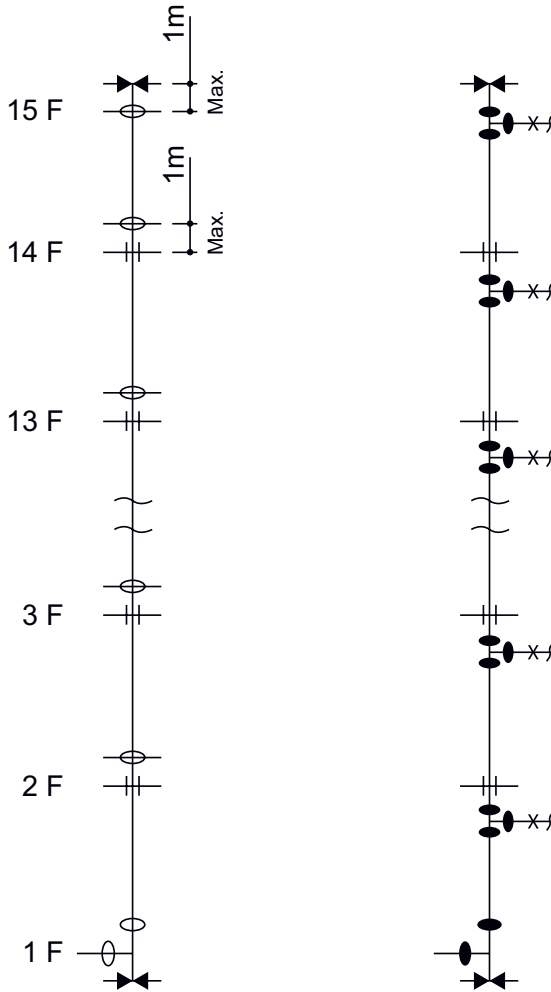

- Flexible Coupling
- Rigid Coupling
- Anchor
- Sway brace

- Anchors should be sufficient to hold the weight of water-filled pipe and pressure thrusts.
- Pipe guides (sway braces) should be such as to brace lateral movement of the system.

Anchors for risers ()

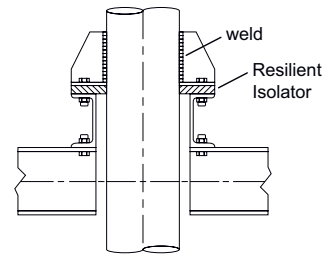

Sway brace for risers ()

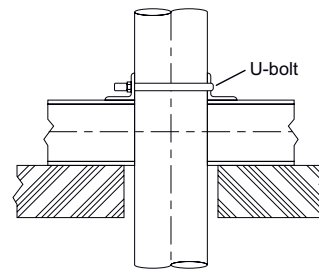

Anchor ()

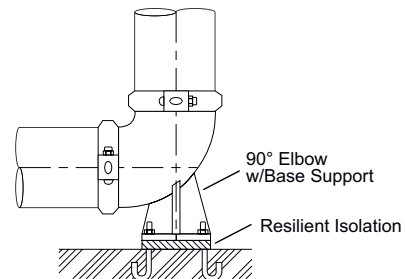

Sway brace ()

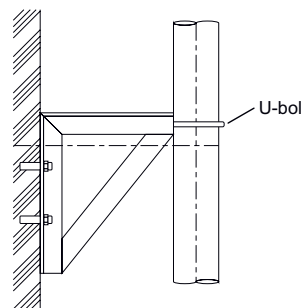



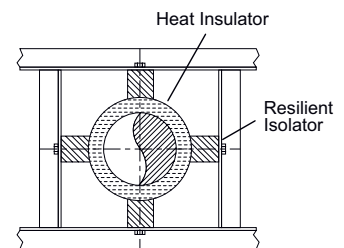





Sway brace ()





Over the past 50 years great advances have been made in synthetic elastomer technologies, allowing us to offer a full range of gasket materials for a wide variety of piping applications. Shurjoint utilizes the finest materials available in our gaskets which are engineered and designed to meet and exceed industry standards such as ASTM D2000, AWWA C606, NSF61, IAPMO, etc. Our continual research, development and testing all serve to advance this field and to develop new and superior solutions for our changing industry. Selecting the proper gasket for the intended service application requires careful consideration of many factors to assure maximum gasket life. Those factors include temperature, fluid media and concentration, and continuity of service. The gaskets color coding helps to identify the gasket grade and compound.

GASKET GRADE INDEX

COMPOUND	GRADE	COLOR CODE	GENERAL SERVICE RECOMMENDATIONS	MAXIMUM TEMP. RANGE
EPDM	E	 Green Stripe	Good for cold & hot water up to +230°F (+110°C). Also good for services for water with acid, water with chlorine, deionized water, seawater and waste water, dilute acids, oil-free air and many chemicals. Not recommended for petroleum oils, mineral oils, solvents and aromatic hydrocarbons.	-30°F (-34°C) to +230°F (+110°C)
Nitrile	T	 Orange Stripe	Good for petroleum oils, mineral oils, vegetable oils, non-aromatic hydrocarbons, many acids and water +150°F (+65°C).	-20°F (-29°C) to +180°F (+82°C)
EPDM	Lube-E	 Violet Stripe	UL approved pre-lubricated gasket designed specifically only for the fire protection industry.	-30°F (-34°C) to +150°F (+65°C)
White Nitrile	A	 White Gasket	Good for oily and greasy food products and processing, as well as pharmaceutical and cosmetics manufacturing. Compounded from FDA approved ingredients (CFR Title 21 Part 177.2600).	+20°F (-7°C) to +180°F (+82°C)
Silicone	L	 Red Gasket	Good for dry, hot air without hydrocarbons and some high temperature chemical services. May also be used for fire protection dry systems.	-30°F (-34°C) to +350°F (+177°C)
Neoprene	V	 Yellow Stripe	Good for hot lubricating oils and certain chemicals.	-30°F (-34°C) to +180°F (+82°C)
Fluoro-elastomer	O	 Blue Stripe	Good for many oxidizing acids, petroleum oils, halogenated hydrocarbons, lubricants, hydraulic fluids, organic liquids and air with hydrocarbons to +300°F (+149°C).	+20°F (-7°C) to +300°F (+149°C)
Epichloro-hydrin	M2	 White Stripe	Good for aromatic fuels at low temperatures and also for ambient temperature water.	-40°F (-40°C) to +160°F (+71°C)

SPECIAL GASKETS FOR AWWA DUCTILE IRON PIPE

COMPOUND	GRADE	COLOR CODE	GENERAL SERVICE RECOMMENDATIONS	MAXIMUM TEMP. RANGE
Nitrile	S	 Red Stripe	Specially compounded for use with AWWA ductile iron pipe and used for petroleum products, mineral oils, vegetable oils and air with oil vapors.	-20°F (-29°C) to +180°F (+82°C)
Halogenated Butyl	M	 Brown Stripe	Good for water services, mild dilute acids, oil-free air and many chemicals. The compound is UL classified per NSF/ANSI 61 & NSF/ANSI 372. (AWWA ductile iron pipe use)	-20°F (-29°C) to +200°F (+93°C)

Please note that EPDM grade "EH" gaskets can be used for all applications and services that EPDM grade "E" gaskets are suitable for.

WARNING!

EPDM gaskets for water services are not recommended for steam services. Failure to select the proper gasket and compound may result in joint leakage or failure resulting in personal and or property damage. Gaskets should never be exposed to temperatures outside their ratings.

Proper gasket selection is essential for the optimum performance of Shurjoint grooved couplings, flange adapters and mechanical tees.

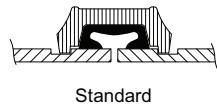

Standard



Reducing

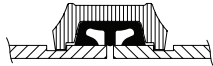

GapSeal



Reducing
(2" x 1½", 2½" x 2", 3" x 2½")



End Protection

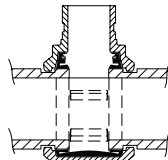

Outlet Coupling



FastFit™

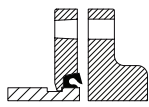

Flange Adapter

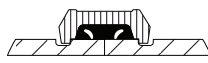

AWWA Ductile Iron Pipe

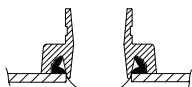

Mechanical Tee



IPS to AWWA

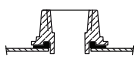

Saddle-Let

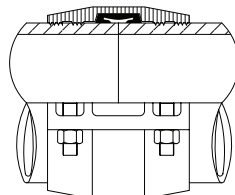

HDPE Pipe



Wildcat

1. GASKET STYLES

Shurjoint grooved couplings utilize several different gasket styles, standard, GapSeal, EP (End Protection) and FF (Fast Fit). GapSeal gaskets are compatible with standard gaskets and they are interchangeable with each other. Other special styles are not compatible with standard or GapSeal gaskets. Always use the correct gasket style for the coupling model you selected.

2. VACUUM SERVICE

Shurjoint standard gaskets are designed to seal well under vacuum conditions up to 10 inHg (absolute)/ 254 mmHg (absolute) which may occur when a system is drained. For continuous services greater than 10 inHg (absolute)/254 mmHg (absolute), the use of GapSeal gaskets or EP (End Protection) gaskets in combination with rigid style couplings is recommended. Contact Shurjoint for specific recommendations.

3. DRY PIPE AND FREEZER SERVICES

Shurjoint recommends the use of GapSeal Grade "E" gaskets for dry pipe fire protection systems and freezer applications. The GapSeal gasket closes off the gap between the pipes or gasket cavity. This will prevent any remaining liquid from entering the cavities and freezing when the temperature drops. Rigid couplings are preferred for dry pipe, freezer and vacuum applications. Reducing couplings are not recommended for these applications.

NOTE: Do not use the Shurjoint Lubricant for dry pipe and freezer systems, instead use a petroleum free silicone based lubricant.

4. NSF/ANSI 61 STANDARD

NSF/ANSI 61 classified gaskets are good for potable water services. The classification categories are 'cold' which is limited to +86°F (+30°C) (or maximum ambient distribution temperatures of unheated water) maximum and 'hot' which is limited to +180°F (+82°C) (or scalding temperatures of hot domestic water).

5. NSF/ANSI 372 STANDARD

MAXIMUM LEAD CONTENT (FORMERLY ANNEX G):
Product complies with NSF/ANSI 372 and conforms with lead content requirements for "lead free" plumbing as defined by California, Vermont, Maryland and Louisiana State laws and the U. S. Safe Drinking Water Act in effect as of Jan. 4, 2014.

6. LUBRICANT

Shurjoint Lubricant is recommended for proper gasket installation to prevent the gasket from being pinched. Apply a thin coat to the gasket exterior, gasket lips and/or housing interiors. Shurjoint Lubricant is available in one pound (450 grams) and one quart (2 pounds or 900 grams) containers. Certified to NSF/ANSI 61.



The following are general service recommendations only and the information provided is based on the best information available from various resources including elastomer manufacturers, leading rubber molders, industry publications and our own laboratory testing and field experience. The information contained herein shall be considered for evaluation purposes and not as a guarantee. When and wherever possible, gasket materials should be tested with simulated service conditions to determine suitability for the intended service application. Unless otherwise noted, the recommendations are based on ambient temperatures. These recommendations do not apply to rubber lined products or rubber sealed valves. If more than one gasket grade is listed the preferred grade is listed first for general services. For chemicals not listed, a combination of chemicals listed or not, service temperatures not listed or borderline services, contact a Shurjoint Engineering Representative for a recommendation.

Note: NR = Not Recommended

CHEMICAL SERVICES	
CHEMICAL COMPOSITION	GASKET GRADE
Acetaldehyde	E
Acetamide	T
Acetic Acid up to 10% 100°C (38°C)	E/L
Acetic Acid up to 10-50% 100°C (38°C)	L
Acetic Acid, Glacial 100°C (38°C)	L
Acetic Anhydride	E
Acetone	E
Acetonitrile	E/T
Acetophenone	E
Acetylene	E/T
Acrylic Resin	V
Acrylonitrile	NR
Adipic Acid	T
Air, oil free	E
Air with vaporized oil	T
Alkalis	E
Allyl Alcohol to 96%	E
Allyl Chloride	NR
Alum Sulfuric Acid	O
Alums	E/T
Aluminum Chloride	E/T
Aluminum Fluoride	E/T/O
Aluminum Hydroxide	E/O
Aluminum Nitrate	E/T/V
Aluminum Oxychloride	T
Aluminum Phosphate	E
Aluminum Salts	E/T
Aluminum Sulfate	E/T
Alums	E/T
Ammonia Anhydrous (Pure Ammonia)	NR
Ammonia Gas, Cold	E
Ammonia, Aqua, 10-25%	E
Ammonia, Liquid	E
Ammonium Alum	V
Ammonium Bifluoride	T
Ammonium Carbonate	E
Ammonium Chloride	E/T
Ammonium Fluoride	E
Ammonium Hydroxide	E
Ammonium Metaphosphate	E
Ammonium Nitrate	E/T
Ammonium Nitrite	E
Ammonium Persulfate, to 10%	E
Ammonium Phosphate	T
Ammonium Sulfamate	T
Ammonium Sulfate	E/T
Ammonium Sulfide	E
Ammonium Thiocyanate	E
Amyl Acetate	E
Amyl Alcohol	E
Amyl Borate	V
Amyl Chloride	NR
Amyl Chloronaphthalene	T
Anderol	O
Aniline	E
Aniline Dyes	E
Aniline Hydrochloride	E
Aniline Oil	E
Animal Fats	A
Anthraquinone	NR

CHEMICAL SERVICES	
CHEMICAL COMPOSITION	GASKET GRADE
Anthraquinone Sulfonic Acid	NR
Antimony Chloride	E
Antimony Trichloride	E
Argon Gas	E/O
Aroclor(S)	O
Arsenic Acid, to 75%	E/T/O
Arylsulfonic Acid	NR
ASTM #1, 2 & 3 Oil	T
Barium Carbonate	E
Barium Chloride	E/T
Barium Hydroxide	E/T
Barium Nitrate	V
Barium Sulfide	T
Beer	A
Beet Sugar liquors	A
Benzaldehyde	E
Benzene	O
Benzine (see Petroleum Ether)	O
Benzoic Acid	E
Benzol	O
Benzyl Alcohol	E
Benzyl Benzoate	E
Benzyl Chloride	E
Black Sulfate Liquor	T
Blast Furnace Gas	T
Bleach, 12% Active Cl ₂	E
Borax Solutions	E
Bordeaux Mixture	E
Boric Acid	E/T
Bromine	O
Bromine Water	V
Butane Gas	T
Bromotoluene	NR
Butanol (see Butyl Alcohol)	E/T
Butter	A
Butyl Acetate Ricinoleate	E/T
Butyl Alcohol	E/T
Butyl "Cellosolve Adipate"	E/T
Butyl Phenol	E
Butyl Stearate	T/O
Butylene	T/O
Butylene Glycol	E
Butyne Diol	NR
Calcium Acetate	T
Calcium Bisulphite	T/O
Calcium Carbonate	E/T
Calcium Chlorate	E/T
Calcium Chloride	E/T
Calcium Hydroxide (Lime)	E/T
Calcium Hypochlorite	E
Calcium Hypochloride	E
Calcium Nitrate	E/T/V
Calcium Sulfate	E/T
Calcium Sulfide	E/T
Caliche Liquors	T
Cane Sugar Liquors	A
Carbitol	E/T
Carbonic Acid, Phenol	O
Carbon Bisulphide	O
Carbon Dioxide, Dry	E/T

CHEMICAL SERVICES	
CHEMICAL COMPOSITION	GASKET GRADE
Carbon Dioxide, Wet	E/T
Carbon Disulphide	O
Carbon Monoxide	E
Carbon Tetrachloride	O
Carbonic Acid, Dry	O
Caster Oil	T/A
Caustic Potash	E/T
Cellosolve	E/V
Cellosolve Acetate	E
Cellosolve (Alcohol Ether)	E
Cellulose Acetate	E
Cellulube 220 (Tri-Aryl-Phosphate)	E
Cellulube Hydraulic Fluids	E
China Wood Oil, Tung Oil	T
Chloric Acid to 20%	E
Chlorine, Dry	O
Chlorine, Water 4000 PPM (max.)	E
Chlorinated Paraffin (Chlorococane)	T
Chloroacetic Acid	E
Chloroacetone	E
Chlorobenzene	O
Chloralhydrate	NR
Chlorobromomethane	NR
Chloroform	O
Chlorosulphonic Acid	NR
Chrome Alum	E/T
Chromic Acid, to 10%	O
Chromic Acid, to 25%	O
Chrome Plating Solutions	O
Citric Acid, Saturated	E
Citric Acid	E/T
Coconut Oil	A
Cod Liver Oil	A
Coke Oven Gas	T/O
Copper Carbonate	E/T
Copper Chloride	E/T
Copper Cyanide	E/T
Copper Fluoride	E
Copper Nitrate	E/T
Copper Sulfate	E/T
Corn Oil	A
Cotton Seed Oil	A
Creosol, Cresylic Acid	O
Creosote, Coal Tar	T/O
Creosote, Wood	T/O
Cupric Fluoride	E/T
Cupric Sulfate	E/T
Cyclohexane (Alicyclic Hydrocarbon)	O
Cyclohexanol	V/O
Cyclohexanone	E
Deionized Water	E
Dextrin	T
Diacetone Alcohol	V
Dibutyl Phthalate	E
Dichloro Difloro Methane	T
Dicyclohexylamine	T
Diesel Oil	T
Diethyl Ether	T
Diethyl Sebacate	E
Diethylamine	T

CHEMICAL SERVICES	
CHEMICAL COMPOSITION	GASKET GRADE
Diethylene Glycol	E/T
Digester Gas	T
Dimethylamine	T
Dioctyl Phthalate	E
Dioxane	E
Dipentene (Terpene-Hydrocarbon)	T
Dipropylene Glycol	T
Dowtherm A	O
Dowtherm E	O
Dowtherm SR-1	T/E
Ethane	E
Ethanolamine	E
Ethers	NR
Ethyl Acetoacetate	E
Ethyl Acrylate	L
Ethyl Alcohol (Ethanol)	E
Ethyl Cellulose	E
Ethyl "Cellusolve"	E
Ethyl Chloride	E/T
Ethyl Ether	T
Ethyl Oxalate	E
Ethyl Silicate	T
Ethylene Chlorohydrin	E
Ethylene Diamine	E/T
Ethylene Dichloride (Dichloroethane)	O
Ethylene Glycol	E/T
Ethylene Oxide	NR
Fatty Acid	A
Ferric Chloride, to 35%	E/T/O
Ferric Chloride, Saturated	E
Ferrous Nitrate	V
Ferric Hydroxide	E
Ferric Sulfate	T
Fish Oils (Solubles)	A
Fire Fighting Foam Concentrate	E/O
Fluboric Acid	E/T
Fluorine Gas, Wet	NR
Fluorosilicic Acid, to 30%	V
Fly Ash	E
FM200 HFC-227ea	E
Foam	E
Fog Oil	T
Formaldehyde	E/T
Formamide	E/T
Formic Acid, to 25%	E
Freon 11, 130°F (54°C)	T
Freon 12, 130°F (54°C)	T
Freon 113 130°F (54°C)	T
Freon 114, 130°F (54°C)	T
Freon F-12	T
Freon 123	NR
Freon 134a, 176° (80°C)	E/T
Freon F-21	NR
Freon 22, 130°F (54°C)	V
Fructose	E/T
Fuel Oil	T
Fumaric Acid	E
Furan	NR
Furfuryl Alcohol	E
Gallic Acid	NR
Gasoline, Refined	T
Gasoline, Refined, Unleaded	O
Gelatin	A
Glucose	A
Glue	E/T
Glycerin	E/T
Glycerol	E/T
Glycol	E/T
Glycolic Acid	E

CHEMICAL SERVICES	
CHEMICAL COMPOSITION	GASKET GRADE
Grease	T/V/O
Green Sulfate Liquor	T
Halon 1301	E
Heptane	T
Hexaldehyde	E
Hexane	T
Hexanol	V/T
Hexanol Tertiary	T
Hexyl Alcohol	V/T
Hexylene Glycol	T
Hydrobromic Acid, to 40%	E
Hydrochloric Acid, to 36%, 75°F (24°C)	E
Hydrochloric Acid, to 36%, 158°F (70°C)	O
Hydrocyanic Acid	E
Hydrofluoric Acid, to 75%, 75°F (24°C)	O
Hydrofluosilicic Acid	E
Hydrocyanic Acid, to 10%	E
Hydrofluoric Acid, to 30%	V/O
Hydrofluosilicic Acid, to 50%	T
Hydrogen Phosphide	NR
Hydrogen Gas, Cold	E/T
Hydrogen Gas, Hot	E
Hydrogen Peroxide, to 50%	L
Hydrogen Peroxide, to 90%	O
Hydrogen Sulfide	E
Hydroquinone	T/O
Hydroxylamine Sulfate	E
Hypochlorous Acid, Dilute	E
Isododecane	V
Isobutyl Alcohol	E
Iso Octane, 100°F (38°C)	T
Isopropyl Acetate	E
Isopropyl Ether	T
JP-3	T
JP-4	T/O
JP-5	T/O
JP-6, 7, 8	T
Kerosene	T
Ketones	E
Lactic Acid	A
Lard Oil	V
Latex (1% Styrene & Butadiene)	O
Lauric Acid	T
Lauryl Chloride	NR
Lavender Oil	T
Lead Acetate	T
Lead Chloride	E
Lead Sulfamate	V
Lead Sulfate	T
Lime and H2O	E/T
Lime Sulfur	O
Linoleic Acid	O
Lithium Bromide	T
Lithium Bromide (Brine)	T/O
Linseed Oil	A
Lithium Chloride	T/O
Lubricating Oil, Refined	T
Lubricating Oil, Sour	T
Lubricating Oil, to 150°F (66°C)	T
Lubricating Oil, 150°F (66°C) to 180°F (82°C)	V/T
Magnesium Chloride	E/T
Magnesium Hydroxide	E/T
Magnesium Nitrate	E/V
Magnesium Sulfate	E/T
Maleic Acid, Saturate	T
Malic Acid	T
Mercuric Chloride	E/T
Mercuric Cyanide	E/T

CHEMICAL SERVICES	
CHEMICAL COMPOSITION	GASKET GRADE
Mercurous Nitrate	E/T
Mercury	E/T
Methane	T
Methyl Acetate	V
Methyl Alcohol, Methanol	E/T
Methyl Cellosolve (Ether)	V
Methyl Chloride	O
Methyl Ethyl Ketone	NR
Methyl Isobutyl Carbinol	E
Methylene Chloride	O
Methylene Chlorobromide	NR
Methylene Dichloride 100°F (38°C)	O
MIL-L7808	O
MIL-05606	O
MIL-08515	O
Milk	A
Mineral Oils	T
Naphta	O
Naohtalene	NR
Naptha, 160°F (71°C)	O
Napthenic Acid	T
Natural Gas	T
Nevoil	E
Nickel Acetate to 10%, 100°F (38°C)	V
Nickel mmonium Sulfate	V
Nickel Chloride	E/T
Nickel Nitrate	V
Nickel Plating Solution	
125°F (52°C) - Max.	E/T
Nickel Sulfate	E/T
Nitric Acid to 10%, 75°F (24°C) - Max.	E
Nitric Acid, 10-50%, 75°F (24°C) - Max	O
Nitric Acid, 50-86%, 75°F (24°C)	O
Nitric Acid, Red Fuming	O
Nitrocellulose	V
Nitrogen	E
Nitromethane	E
Nitrous Oxide	E
NOVEC 1230 FK-5-1-12	E
Octyl Alcohol VOGisogiric Acid, to 75%, 150°F (66°C)	O
Oil, Crude Sour	T
Oil, Motor	T
Oleic Acid	T
Olive Oil	T/A
Oronite 8200 Silicate Ester Fluid	O
Orthodichlorobenzene	O
OS-45 Silicate Ester Fluid	O
OS-45-1	O
Oxalic Acid	E
Oxygen, Cold	E
Ozone (100 ppm)	E
Palm Oil	T/A
Peanut Oil	A
Palmitic Acid	T
Pentane	T
Perchloric Acid	NR
Perchloroethylene	O
Petroleum Ether (see Benzene)	O
Petroleum Oils	T
Phenol (Carbolic Acid)	O
Phenylhydrazine	E
Phenylhydrazine Hydrochloride	E
Phosphate Ester	E
Phosphoric Acid, to 50%	E
Phosphoric Acid, to 75% and 70°F	E/T
Phosphoric Acid, to 85%, 150°F (66°C) - Max.	O
Phosphate Ester	E

CHEMICAL SERVICES	
CHEMICAL COMPOSITION	GASKET GRADE
Photographic Solutions	T
Phthalic Anhydride	E
Picric Acid	V
Plating Solutions, (gold, brass cadmium, copper, lead, silver, tin, zinc)	V
Polybutene	T
Polyvinyl Acetate, Solid (In Liquid State is 50% solution of Methanol or 60% solution of H2O)	E
Potash	E
Potassium Alum	E/T
Potassium Aluminum Sulfate	E/T
Potassium Bicarbonate	E/T
Potassium Bichromate	E/T
Potassium Borate	E
Potassium Bromate	E
Potassium Bromide	E/T
Potassium Carbonate	E/T
Potassium Chlorate	E
Potassium Chloride	E/T
Potassium Chromate	T
Potassium Cyanide	E/T
Potassium Dichromate	E
Potassium Ferricyanide	E
Potassium Ferrocyanide	E
Potassium Fluoride	E
Potassium Hydroxide	T
Potassium Iodide	V
Potassium Nitrate	E/T
Potassium Perborate	E
Potassium Perchlorate	T
Potassium Permanganate, Saturated to 10%	E
Potassium Permanganate Saturated 10-25%	E
Potassium Persulfate	T
Potassium Silicate	E/T/V
Potassium Sulfate	E/T
Prestone	T
Propane Gas	T
Propanol	E/T
Propargyl Alcohol	E
Propyl Alcohol	E/T
Propylene Dichloride	L
Propylene Glycol	E
Pydraul F-9 and F-150	NR
Pyranol 1467	T
Pyranol 1476	T
Pyroguard "C"	T
Pyroguard "D"	T
Pyroguard 55	E
Pyrrrole	E
Ref. Fuel (70 ISO Octane, 30 Toluene)	T
Rapeseed Oil	A
Rosin Oil	T/V
Salicylic Acid	E
Secondary Butyl Alcohol	T
Sewage	E/T
Silver Nitrate	E
Silver Sulfate	E
Skydrol, 200°F (93°C) - Max.	L
Skydrol 500 Phosphate Ester	E
Soap Solutions	E/T
Soda Ash, Sodium Carbonate	E/T
Sodium Acetate	E
Sodium Alum	T
Sodium Benzoate	E/T
Sodium Bicarbonate	E/T
Sodium Bisulfate	E/T
Sodium Bisulfite (Black Liquor)	E/T

CHEMICAL SERVICES	
CHEMICAL COMPOSITION	GASKET GRADE
Sodium Bromide	E/T
Sodium Carbonate	E/T
Sodium Chlorate	E
Sodium Chloride	E/T
Sodium Cyanide	E/T
Sodium Dichromate, to 20%	E/T
Sodium Ferricyanide	E/T
Sodium Ferrocyanide	E/T
Sodium Fluoride	E/T
Sodium Hydroxide, to 15%	E
Sodium Hydro Sulfide	T
Sodium Hydroxide to 50%	E
Sodium Hypochlorite, to 20%	E
Sodium Metaphosphate	T
Sodium Nitrate	E
Sodium Nitrite	E/T
Sodium Perborate	E
Sodium Peroxide	E
Sodium Phosphate	T
Sodium Phosphate, Dibasic	T
Sodium Phosphate, Monobasic	T
Sodium Phosphate, Tribasic	T
Sodium Silicate	T
Sodium Sulfate	E/T
Sodium Sulfide	E/T
Sodium Sulfite Solution, to 20%	T
Sodium Thiosulfate, "Hypo"	T
Sohovis 47	T
Sohovis 78	T
Solvasol #1	T
Solvasol #2	T
Solvasol #3	T
Solvasol #73	T
Solvasol #74	NR
Soybean Oil	A
Spindle Oil	T
Stannic Chloride	T
Stannous Chloride, to 15%	T
Starch	E/T
Steam	NR
Stearic Acid	T
Stoddard Solvent	T
Styrene	O
Sulfonic Acid	E
Sulphite Acid Liquor	E
Sucrose Solutions	A
Sulfur	E/V
Sulfur Chloride	O
Sulfur Dioxide, Dry	E
Sulfur Dioxide, Wet	E
Sulfur Trioxide, Dry	O
Sulfuric Acid, to 25%, 150°F (66°C)	E
Sulfuric Acid, 25-50%, 200°F (93°C)	O
Sulfuric Acid, 50-95%, 150°F (66°C)	O
Sulfuric Acid, Fuming	O
Sulfuric Acid, Oleum	O
Sulfurous Acid	O
Tall Oil	T
Tannic Acid, all conc. Tanning Liquors (50g. alum. solution, 50g. dichromate solution)	V
Tartaric Acid	E
Tertiary Butyl Alcohol	E/T
Tetrabutyl Titanate	E
Tetrachloroethylene	O
Thionyl Chloride	T
Terpineol	V
Tertiary Butyl Alcohol	E/T/V
Tetrachloroethylene	O
Tetrahydrofuran	NR

CHEMICAL SERVICES	
CHEMICAL COMPOSITION	GASKET GRADE
Tetralin	NR
Thiopenene	NR
Titanium Tetrachloride	O
Toluene, to 30%	T
Transmission Fluid, Type A	O
Triacetin	T
Trichloroethane	O
Trichloroethylene	O
Trichloroethylene, to 200°F (93°C)	O
Tricresyl Phosphate	E
Triethanolamine	E/T
Trisodium Phosphate	E
Tung Oil	T
Turbo Oil #15 Diester Lubricant	O
Turpentine	T
Urea	T/E
Vegetable Oils	T/A
Vinyl Acetate	E
Vinegar	A
Vinyl Chloride	O
Vi-Pex	T
Water, to 150°F (66°C)	E/T/M/S
Water, to 200°F (93°C)	E/M
Water, to 230°F (110°C)	E
Water, to 250°F (121°C)	EH
Water, Acid Mine	E/T
Water, Bromine	O
Water, Chlorinated, to 3500 ppm	E
Water, Chlorine	E
Water, Deionized	E/M
Water, Potable	E-pw
Water, Seawater	E
Water, Waste	E/T/M/S
Whiskey	A
White Liquor	E
Wood Oil	T
Xylene	O
Zinc Chloride, to 50%	E
Zinc Nitrate	E
Zinc Sulfate	E/T

The Shurjoint fire protection series numbers over 600 individual components, including grooved couplings, fittings, flanges, mechanical tees, valves, welding outlets, threaded fittings and more. Applicable products are listed and or approved by various domestic and international approval bodies including UL, FM, VdS, LPCB and others.

HYDROSTATIC TESTS

Approved products are rated in cold water pressure (CWP) tested with a 3 to 5 times test pressure depending on the approval body and pipe size. The minimum working pressure (CWP) shall be 175 psi (12.3 Bar) in accordance with NFPA 13. Approval testing of a coupling is conducted on all different pipe schedules as enrolled and approved working pressures (CWP) are assigned to each individual combination of the coupling and test pipe. Refer to the Approved Pressure Ratings by UL and FM.

HYDROSTATIC TEST PRESSURES MULTIPLE OF CWP

NOM. SIZE	UL	FM	VDS	LPCB
Up to 6" / 150	X5	X4	X4	X4
8" - 12" / 200 -300	X4	X4	X4	X4
14" and above	X3	X4	NA	NA

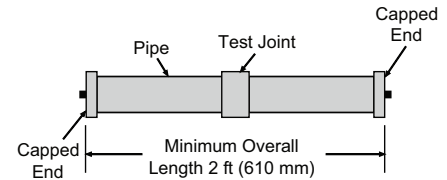

BENDING MOMENT TESTS

The required bending moment per UL and FM is calculated based on twice the weight of water filled pipe over twice the maximum distance between pipe supports as specified in NFPA 13.

See the table to the right for the bending moments per UL and FM on Sch. 40 pipe. This bending moment is twice that required by ASTM F1476.

In addition to the hydrostatic and bending moment tests, couplings must meet other requirements including gasket performance tests.

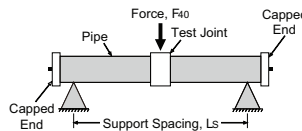
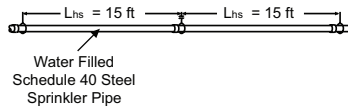

REQUIRED BENDING MOMENT UL & FM

NOM. SIZE (INCHES)	UL		FM	
	MOMENT NM	MOMENT LB-FT	MOMENT NM	MOMENT LB-FT
1-1/2	1098	810	1100	810
2	1559	1150	1560	1150
2-1/2	2400	1770	2400	1770
3	3289	2426	3290	2425
4	4942	3645	4975	3670
5	7102	5238	7105	5240
6	9606	7085	9615	7090
8	15326	11304	15335	11310
10	22757	16785	22790	16805
12	31116	22950	31145	22970
14	37217	27450		
16	48597	35843		

FLEXIBLE COUPLING

NFPA 13 defines a flexible coupling as "a listed coupling or fitting that allows axial displacement, rotation, and at least 1 degree of angular movement of the pipe without inducing harm on the pipe. For pipe diameters of 8 in. and larger, the angular movement shall be permitted to be less than 1 degree but not less than 0.5 degrees." (NFPA 13 - 2007 3.5.4)

For sprinkler systems, NFPA 13 specifies the use of flexible couplings to protect the system against damage from earthquakes and lists some specific examples of how and where they should be used. Designers and installers should design their fire protection systems in compliance with this standard.

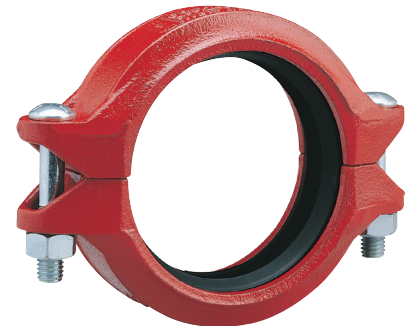

MINIMUM PIPE SCHEDULES

Standard cut and roll grooving connections have limitations of minimum pipe schedules. Special care is required for thin wall pipe. Factory Mutual Research Group (FM) outlines the minimum pipe schedules to be used for cut and roll grooving in their FM Class 1920 standard as follows:

NOMINAL PIPE SIZE IN.	GROOVING METHOD	MINIMUM PIPE SCHEDULE
6 or smaller	Cut	Schedule 40
8 or larger	Cut	Schedule 30
2 or smaller	Rolled	Schedule 5
6 or smaller	Rolled	Schedule 10, Thinwall, Lightwall
8 or larger	Rolled	0.188 in. (4.8 mm) wall

(FM Class 1920 -2007, Table 3.2.2)

- Approved grooved couplings and fittings are good for use in both wet and dry sprinkler systems.
- Typical applications of flexible couplings (models 7705, 7706 & 7707) are in sprinkler risers, in feed mains passing through walls from one building area to another, in locations subject to earthquakes, in the discharge line from above ground pump suction tanks, in new connections to existing feed mains and in air or water fire service lines subject to excessive vibration or difficult alignment.
- Approved grooved couplings are limited to use with rolled or cut-groove ended pipe, valves and fittings at a minimum rated working pressure of 175 psi (1205 kPa) and are suitable for above ground service.
- Grooves should be processed according to ANSI/AWWA C606 (latest edition) Grooved and Shouldered Joints.
- Installation must be made according to the manufacturer's instructions and requirements.
- Approved grooved couplings may be used in underground service subject to the installation restrictions placed upon the pipe and to the coupling manufacturer's recommendations and requirements.
- Approved grooved couplings have been evaluated for a maximum ambient temperature of 225°F (107°C), suitable for normal warehouse protection.
- Threaded size of sprinkler piping is limited to 1 inch (25 mm) nominal.
- Threaded connections can be made to approved threadable thinwall pipe or to Schedule 40 pipe.

Source: FM Approval Guide

- For pressure ratings for special pipes, DIN and JIS pipe sizes, and large diameter sizes 14" - 24", contact Shurjoint for details.
- Models K-9 and 7771 rigid couplings are also available. For pressure ratings, contact Shurjoint for details.

COUPLINGS & FLANGE ADAPTERS SCH. 40 & STD WALL PIPE

SIZE IN	WALL IN	7705		K-9		7707		7771		Z05		Z07		7041		7043		7706		
		UL	FM	UL	FM	UL	FM	UL	FM	UL	FM	UL	FM	UL	FM	UL	FM	SIZE (IN)	UL	FM
3/4	0.113	-	-	-	-	500	-	-	-	-	-	-	-	-	-	-	-	2 x 1-1/2	300	300
1	0.133	300	300	-	-	500	-	-	-	-	-	-	500	-	-	-	-	2-1/2 x 2	300	300
1-1/4	0.140	300	300	300	300	500	-	-	-	350	350	500	500	-	-	-	-	3 x 2	300	300
1-1/2	0.145	300	300	300	300	-	500	-	500	350	350	500	500	-	-	-	-	3 x 2-1/2	300	300
2	0.154	300	300	300	300	500	500	300	300	350	350	500	500	175	300	300	300	4 x 2	300	300
2-1/2	0.203	300	300	300	300	500	500	300	300	350	350	500	500	175	300	300	300	4 x 2-1/2	300	300
3	0.216	300	300	300	300	500	500	300	300	350	350	500	500	175	300	300	300	4 x 3	300	300
4	0.237	300	300	300	300	500	500	300	300	350	350	500	500	175	300	300	300	6 x 3	300	300
5	0.258	300	300	300	300	500	500	300	300	350	350	400	400	175	300	300	300	6 x 4	300	300
6	0.280	300	300	300	300	500	500	300	300	350	350	400	400	175	300	300	300	8 x 6	300	300
8	0.322	300	300	300	300	500	500	300	300	350	350	400	400	175	300	300	300	-	-	-
10	0.375	175*	250	-	-	300	500	175	200	-	-	350	350	175	175	300	300	-	-	-
12	0.375	175*	250	-	-	300	300	175	300	-	-	350	350	175*	175	300	300	-	-	-

*0.188" wall, *0.330 wall

SIZE IN	WALL IN	7705H	
		UL	FM
8	0.322	450	450

Unit: psi

SCH. 10 & BS 1387 MEDIUM PIPE

SIZE IN	WALL IN	7705		K-9		7707		7771		Z05		Z07		7041		7043		7706		
		UL	FM	UL	FM	UL	FM	UL	FM	UL	FM	UL	FM	UL	FM	UL	FM	SIZE (IN)	UL	FM
3/4	0.083	-	-	-	-	500	-	-	-	-	-	-	-	-	-	-	-	2 x 1-1/2	300	300
1	0.109	300	300	-	-	500	-	-	-	-	-	-	500	-	-	-	-	2-1/2 x 2	300	300
1-1/4	0.109	300	300	300	300	500	-	-	-	350	350	500	500	-	-	-	-	76.1 x 2	300	300
1-1/2	1.109	300	300	300	300	-	-	-	500	350	350	500	500	-	-	-	-	3 x 2	300	300
2	0.110	300	300	300	300	450	450	300	300	350	350	500	500	175	300	300	300	3 x 2-1/2	300	300
2-1/2	0.120	300	300	300	300	450	450	300	300	350	350	500	500	175	300	300	300	3 x 76.1	300	300
76.1	0.142	300	300	300	-	500	500	-	300	300	-	-	-	175	-	-	-	4 x 2	300	300
3	0.120	300	300	300	300	450	450	300	300	350	350	500	500	175	300	300	300	4 x 2-1/2	300	300
4	0.120	300	300	300	300	450	450	300	300	350	350	500	500	175	300	300	300	4 x 76.1	300	300
5	0.134	300	300	300	300	450	450	300	300	350	350	400	400	175	300	300	300	4 x 3	300	300
139.7	0.197	300	300	300	-	500	500	-	300	-	-	-	-	175	-	-	-	6 x 3	300	300
6	0.134	300	300	300	300	450	450	300	300	350	350	400	400	175	300	300	300	165.1 x 3	-	300
165.1	0.197	300	300	300	-	500	500	-	300	-	-	-	-	175	-	-	-	6 x 4	300	300
8	0.188	300	300	300	300	450	450	300	300	350	350	400	400	175	300	300	300	165.1 x 4	300	300
10	0.188	175	175	-	-	300	450	175	200	NA	NA	350	350	175	175	300	300	8 x 6	300	300
12	0.250	175*	175	-	-	300	300	175	300	NA	NA	350	350	175*	175	300	300	8 x 165.1	-	300

*0.330 wall

SIZE IN	WALL IN	7705H	
		UL	FM
8	0.188	450	450

Unit: psi

OUTLET COUPLING & MECHANICAL TEES

MODEL	SIZES (IN) (RUN X BRANCH)	SCH. 40/STD		SCH. 10	
		UL	FM	UL	FM
C-7 Outlet Coupling, Threaded	1-1/2 x 1/2, 3/4 & 1	300	300	300	300
	2 x 1/2, 3/4 & 1	300	300	300	300
	2-1/2 x 1/2, 3/4 & 1	300	300	300	300
	3 x 3/4 & 1	300	300	300	300
	4 x 3/4 & 1	300	300	300	300
	6 x 1 & 1-1/2	300	300	300	300
C-7 Outlet Coupling, Grooved	2 x 1	300	300	300	300
	2-1/2 x 1-1/4 & 1-1/2	300	300	300	300
	3 x 1 & 1-1/2	300	300	300	300
	4 x 1-1/2 & 2	300	300	300	300
	6 x 1-1/2 & 2	300	300	300	300
	2 x 1/2, 3/4, 1, 1-1/4 & 1-1/2	300	300	300	300
M21 Mechanical Tee, Threaded (NPT or BSPT)	2-1/2 x 1/2, 3/4, 1, 1-1/4 & 1-1/2	300	300	300	300
	76.1 x 1/2, 3/4, 1, 1-1/4 & 1-1/2	300	300	300	300
	3 x 1/2, 3/4, 1, 1-1/4, 1-1/2 & 2	300	300	300	300
	4 x 1/2, 3/4, 1, 1-1/4, 1-1/2, 2 & 2-1/2	300	300	300	300
	4 x 76.1	300	300	300	300
	4 x 3	175	175	175	175
	5 x 2 & 2-1/2	300	300	-	300
	5 x 3	300	-	-	-
	139.7 x 2, 76.1 & 3	300	300	300	300
	6 x 1-1/4, 1-1/2, 2 & 2-1/2	300	300	300	300
	6 x 3 & 4	175	175	175	175
	165.1 x 1-1/4, 1-1/2, 2 & 76.1	300	300	300	300
	165.1 x 3 & 4	175	175	175	175
	M22 Mechanical Tee, Grooved	2 x 1, 1-1/4 & 1-1/2	300	300	300
2-1/2 x 1, 1-1/4 & 1-1/2		300	300	300	300
76.1 x 1, 1-1/4 & 1-1/2		300	300	300	300
3 x 1, 1-1/4, 1-1/2 & 2		300	300	300	300
4 x 1, 1-1/4, 1-1/2, 2 & 2-1/2		300	300	300	300
4 x 76.1		300	300	300	300
5 x 2 & 2-1/2		300	300	300	300
4 x 3		175	175	175	175
139.7 x 76.1		300	300	300	300
6 x 1-1/4, 1-1/2, 2 & 2-1/2		300	300	300	300
6 x 3 & 4		175	175	175	175
165.1 x 1-1/4, 1-1/2, 2 & 76.1		300	300	300	300
165.1 x 3 & 4		175	175	175	175
7721 Threaded (NPT or BSPT)		4 x 3	300	300	300
	8 x 2, 2-1/2, 3 & 4	300	300	300	300
	8 x 76.1	300	300	300	300
7722 Grooved	4 x 3	300	300	300	300
	8 x 2, 2-1/2, 3 & 4	300	300	300	300
723 Threaded (NPT or BSPT)	1-1/4 x 1/2 x 3/4 & 1	300	300	300	300
	1-1/2 x 1/2 x 3/4 & 1	300	300	300	300
	2 x 1/2 x 3/4 & 1	300	300	300	300
	2-1/2 x 1/2 x 3/4 & 1	300	300	300	300

mm size pipe per EN 10255

VALVES & COMPONENTS

MODEL	SIZE RANGE	UL	FM
RCV Riser Check Valve	2-1/2" thru 6"	300	300
726 Y-Strainer	2" thru 6"	300	-
	8" thru 12"	175	-
SJ-300F Butterfly Valve	2-1/2" thru 6"	300	300
	8"	300	-

Unit: psi

STAINLESS STEEL SERIES

SCH. 40S & 10S PIPE

SIZE IN	SCH. 10S WALL (IN)	SS-7		SS-8		SS-41		SS-723		
		UL	FM	UL	FM	UL	FM	SIZE (IN)	UL	FM
1	0.109	300	300	300	300	-	-	1-1/4 x 1/2	300	300
1-1/4	0.109	300	300	300	300	-	-	1-1/4 x 3/4	300	300
1-1/2	0.109	300	300	300	300	-	-	1-1/4 x 1	300	300
2	0.109	300	300	300	300	175	300	1-1/2 x 1/2	300	300
2-1/2	0.120	300	300	300	300	175	300	1-1/2 x 3/4	300	300
3	0.120	300	300	300	300	175	300	1-1/2 x 1	300	300
4	0.120	300	300	300	300	175	300	2 x 1/2	300	300
5	0.134	300	300	300	300	-	-	2 x 3/4	300	300
6	0.134	300	300	250	300	175	300	2 x 1	300	300
8	0.148	300	300	-	300	-	-			

Unit: psi

COPPER TUBING SERIES

TYPE K & TYPE L COPPER TUBING

SIZE IN	TYPE K WALL (IN)	TYPE L WALL (IN)	C341	
			UL	FM
2	0.083	0.070	200	-
2-1/2	0.095	0.080	200	-
3	0.109	0.090	200	-
4	0.134	0.110	200	-
5	0.160	0.123	200	-
6	0.192	0.140	200	-

Unit: psi

FM: Type K only

MODEL	SIZE RANGE	UL	FM
C10 90 Elbow	2" through 4"	175	200
C11 45 Elbow	2" through 4"	175	200
C20 Tee	2" through 6"	175	200
C21 Reducing Tee	2-1/2" x 2" thru 6" x 5"	200	-
C26 Reducing Tee	2" x 3/4" thru 4" x 1/2"	200	-
C50 Conc. Reducer	2-1/2" x 2" thru 6" x 5"	200	-
C52 Conc. Reducer	2" x 1" thru 4" x 2"	200	-
C60 Cap	2" thru 4"	200	200

Unit: psi

GROOVED-END FITTINGS

MODEL	SIZE RANGE	UL	FM
901 S/R 90 Elbow	2" thru 8"	300	300
903 S/R Tee	2" thru 8"	300	300
	76.1, 165.1	300	-
7110 90 Elbow	1" thru 8"	300	500
	10" 12"	300	300
	14" thru 18"	300	175
	24"	-	175
7111 45 Elbow	1"	-	500
	1-1/4" thru 8"	300	500
	10" 12"	300	300
	14" thru 18"	300	175
	20"	250	250
	24"	250	175
7110DR Drain Elbow	2" thru 6"	300	300
7110LR 1.5D Elbow	2" thru 8"	300	300
7112 22-1/2 Elbow	1-1/4"	-	300
	1-1/2"	500	300
7113 11-1/4 Elbow	2" thru 8"	300	300
	1-1/4" thru 1-1/2"	-	300
	2" thru 8"	300	500
7120 Tee	1-1/4" thru 8"	300	500
	10" thru 14"	300	300
	18"	300	-
7121 Reducing Tee	2" x 1-1/2" thru 8" x 6"	300	300
	12" x 10"	300	-
7125 Bullhead Tee	2" x 2-1/2" thru 4" x 6"	300	300
7127 Standpipe Tee	5" x 8" thru 6" x 8"	300	-
	4" x 2-1/2"	300	300
7130 Lateral	6" x 2-1/2"	300	-
	2" thru 8"	300	300
7135 Cross	2" thru 6"	300	300
	8"	300	-
7150 Conc. Reducer	2" x 1-1/2" thru 14" x 12"	300	300
	16" x 8" thru 18" x 16"	300	-
7150F Socket Adapter	1-1/2" x 1" thru 4" x 2-1/2"	300	300
	5" x 1-1/2" thru 6" x 4"	300	-
7150M Red. Nipple	1-1/2" x 1" thru 6" x 4"	300	300
7160T Transition Fitting	2" x 1" thru 6" x 2"	300	300
7151 Ecc. Reducer	2-1/2" x 2" thru 8" x 6"	300	300
	10" x 8" thru 14" x 12"	-	300
7160 End Cap	1-1/4" thru 12"	300	300
	10" thru 12"	300	300
7160H End Cap	14" thru 18"	300	175
	20" thru 24"	250	175
7170 Flange Adapter	2-1/2" thru 6"	175	175
7180 Flange Adapter	2" thru 8"	300	300
7181 Red. Flange	3" x 2" thru 6" x 4"	-	300
55 Nipple Adapter	1-1/2" thru 2"	300	300
899 End All	1-1/4" x 1/2" thru 2-1/2" x 1"	300	300
850 Sprinkler Hub	2" x 2" x 1" thru 2-1/2" x 2-1/2" x 1"	300	300
851 Sprinkler Hub	2" x 1-1/2" x 1" thru 2-1/2" x 2 x 1"	300	300
853 Sprinkler Hub	1-1/2" x 1" thru 2-1/2" x 1"	300	300

* 20" only for UL

Unit: psi

The following tables show Shurjoint Couplings used on carbon steel, stainless steel pipe, and copper tubing; listed by IAPMO in accordance with CSA B242.

MODEL Z05 RIGID COUPLING

NOM. SIZE	PIPE O.D.	PRESSURE RATINGS		MIN. WALL
		PSI	Bar	
in	in	Roll (mm)		
mm	mm	Cut (mm)		
1-1/4	1.660	350		1.7
32	42.2	24		3.6
1-1/2	1.900	350		1.7
40	48.3	24		3.7
2	2.375	350		1.7
50	60.3	24		3.9
2-1/2	2.875	350		2.1
65	73.0	24		4.8
3	3.500	350		2.1
80	88.9	24		4.8
4	4.500	350		2.1
100	114.3	24		5.2
5	5.563	350		2.8
125	141.3	24		5.2
6	6.625	350		2.8
150	168.3	24		5.6
8	8.625	350		2.8
200	219.1	24		6.1

MODEL Z07 RIGID COUPLING

NOM. SIZE	PIPE O.D.	PRESSURE RATINGS		MIN. WALL
		PSI	Bar	
in	in	Roll (mm)		
mm	mm	Cut (mm)		
1-1/4	1.660	500		1.7
32	42.2	35		3.6
1-1/2	1.900	500		1.7
40	48.3	35		3.7
2	2.375	500		1.7
50	60.3	35		3.9
2-1/2	2.875	500		2.1
65	73.0	35		4.8
3	3.500	500		2.1
80	88.9	35		4.8
4	4.500	500		2.1
100	114.3	35		5.2
5	5.563	400		2.8
125	141.3	28		5.2
6	6.625	400		2.8
150	168.3	28		5.6
8	8.625	400		2.8
200	219.1	28		6.1
10	10.750	350		3.4
250	273.0	24		6.4
12	12.750	350		4.0
300	323.9	24		7.1

MODEL 7705 FLEXIBLE COUPLING

NOM. SIZE	PIPE O.D.	PRESSURE RATINGS		MIN. WALL
		PSI	Bar	
in	in	Roll (mm)		
mm	mm	Cut (mm)		
1-1/4	1.660	300		1.7
32	42.2	20		3.6
1-1/2	1.900	300		1.7
40	48.3	20		3.7
2	2.375	300		1.7
50	60.3	20		3.9
2-1/2	2.875	300		2.1
65	73.0	20		4.8
3	3.500	300		2.1
80	88.9	20		4.8
4	4.500	300		2.1
100	114.3	20		5.2
5	5.563	300		2.8
125	141.3	20		5.2
6	6.625	300		2.8
150	168.3	20		5.6
8	8.625	300		2.8
200	219.1	20		6.1
10	10.750	175		3.4
250	273.0	12		6.4
12	12.750	175		4.0
300	323.9	12		7.1

MODEL 7705 FLEXIBLE COUPLING

NOM. SIZE	PIPE O.D.	PRESSURE RATINGS		MIN. WALL
		PSI	Bar	
in	in	Roll (mm)		
mm	mm	Cut (mm)		
1-1/4	1.660	500		1.7
32	42.2	35		3.6
1-1/2	1.900	500		1.7
40	48.3	35		3.7
2	2.375	450		1.7
50	60.3	31		3.9
2-1/2	2.875	450		2.1
65	73.0	31		4.8
3	3.500	450		2.1
80	88.9	31		4.8
4	4.500	450		2.1
100	114.3	31		5.2
5	5.563	450		2.8
125	141.3	31		5.2
6	6.625	450		2.8
150	168.3	31		5.6
8	8.625	450		2.8
200	219.1	31		6.1
10	10.750	450		3.4
250	273.0	31		6.4
12	12.750	300		4.0
300	323.9	20		7.1

MODEL 7706 FLEXIBLE COUPLING

NOM. SIZE	PIPE O.D.	PRESSURE RATINGS		MIN. WALL
		PSI	Bar	
in	in	Roll (mm)		
mm	mm	Cut (mm)		
2-1/2 x 2	2.875 x 2.375	300		2.1 x 1.7
65 x 50	73.0 x 60.3	20		4.8 x 3.9
3 x 2	3.500 x 2.375	300		2.1 x 1.7
80 x 50	88.9 x 60.3	20		4.8 x 3.9
3 x 2-1/2	3.500 x 2.875	300		2.1 x 2.1
80 x 65	88.9 x 73.0	20		4.8 x 4.8
4 x 2-1/2	4.500 x 2.875	300		2.1 x 2.1
100 x 65	114.3 x 73.0	20		5.2 x 4.8
4 x 3	4.500 x 3.500	300		2.1 x 2.1
100 x 80	114.3 x 88.9	20		5.2 x 4.8
5 x 4	5.563 x 4.500	300		2.8 x 2.1
125 x 100	141.3 x 114.3	20		5.2 x 5.2
6 x 4	6.625 x 4.500	300		2.8 x 2.1
150 x 100	168.3 x 114.3	20		5.6 x 5.2
8 x 6	8.625 x 6.625	300		2.8 x 2.8
200 x 150	219.1 x 168.3	20		6.1 x 5.6

MODEL SS-5 RIGID COUPLING

NOM. SIZE	PIPE O.D.	PRESSURE RATINGS	MIN. WALL
in	in	PSI	Roll (mm)
mm	mm	Bar	Cut (mm)
1-1/4	1.660	300	1.7
32	42.2	20	3.6
1-1/2	1.900	300	1.7
40	48.3	20	3.7
2	2.375	300	1.7
50	60.3	20	3.9
2-1/2	2.875	300	2.1
65	73.0	20	4.8
3	3.500	300	2.1
80	88.9	20	4.8
4	4.500	300	2.1
100	114.3	20	5.2
5	5.563	300	2.8
125	141.3	20	5.2
6	6.625	300	2.8
150	168.3	20	5.6
8	8.625	300	2.8
200	219.1	20	6.1

MODEL SS-7 RIGID COUPLING

NOM. SIZE	PIPE O.D.	PRESSURE RATINGS	MIN. WALL
in	in	PSI	Roll (mm)
mm	mm	Bar	Cut (mm)
1-1/4	1.660	300	1.7
32	42.2	20	3.6
1-1/2	1.900	300	1.7
40	48.3	20	3.7
2	2.375	300	1.7
50	60.3	20	3.9
2-1/2	2.875	300	2.1
65	73.0	20	4.8
3	3.500	300	2.1
80	88.9	20	4.8
4	4.500	300	2.1
100	114.3	20	5.2
5	5.563	300	2.8
125	141.3	20	5.2
6	6.625	300	2.8
150	168.3	20	5.6
8	8.625	300	2.8
200	219.1	20	6.1

MODEL C305 RIGID COUPLING

NOM. SIZE	PIPE O.D.	PRESSURE RATINGS	MIN. WALL
in	in	PSI	Roll (mm)
mm	mm	Bar	
2	2.125	300	1.1
50	54.0	20	
2-1/2	2.625	300	1.1
65	66.7	20	
3	3.125	300	1.1
80	79.4	20	
4	4.125	300	1.5
100	104.8	20	
5	5.125	300	1.8
125	130.2	20	
6	6.125	300	2.1
150	155.6	20	

MODEL C306 REDUCING COUPLING

NOM. SIZE	PIPE O.D.	PRESSURE RATINGS	MIN. WALL
in	in	PSI	Roll (mm x mm)
mm	mm	Bar	
2-1/2 x 2	2.625 x 2.215	300	1.1 x 1.1
65 x 50	66.7 x 54.0	20	
3 x 2	3.125 x 2.125	300	1.1 x 1.1
80 x 50	79.4 x 54.0	20	
3 x 2-1/2	3.125 x 2.625	300	1.1 x 1.1
80 x 65	79.4 x 66.7	20	
4 x 2-1/2	4.125 x 2.625	300	1.5 x 1.1
100 x 65	104.8 x 66.7	20	
4 x 3	4.125 x 3.125	300	1.5 x 1.1
100 x 80	104.8 x 79.4	20	
5 x 4	5.125 x 4.125	200	1.8 x 1.5
125 x 100	130.2 x 104.8	14	
6 x 4	6.125 x 4.125	200	2.1 x 1.5
150 x 100	155.6 x 104.8	14	

MODEL C307 TRANSITION COUPLING

NOM. SIZE	PIPE O.D.	PRESSURE RATINGS	MIN. WALL
in	in	PSI	Roll (mm)
mm	mm	Bar	
2	2.375 x 2.125	300	1.1
50	60.3 x 54.0	20	
2-1/2	2.875 x 2.625	300	1.1
65	73.0 x 66.7	20	
3	3.500 x 3.125	300	1.1
80	88.9 x 79.4	20	
4	4.500 x 4.125	300	1.5
100	114.3 x 104.8	20	

Note:

Minimum wall thickness listed corresponds to Table 1 of ASME B36.10M Roll/Cut groove for carbon steel & stainless steel pipe end or Table 1 of ASTM B306 for copper tubing.

The following illustrations are part of NFPA 13 – 2013 Annex A Explanatory Material. These are for informational purposes only and not a mandatory requirement. For specific requirements for any other areas of sprinkler systems, refer to the latest version of NFPA 13.

1. FLEXIBLE COUPLINGS FOR MAIN RISERS AND BRANCH LINE RISER

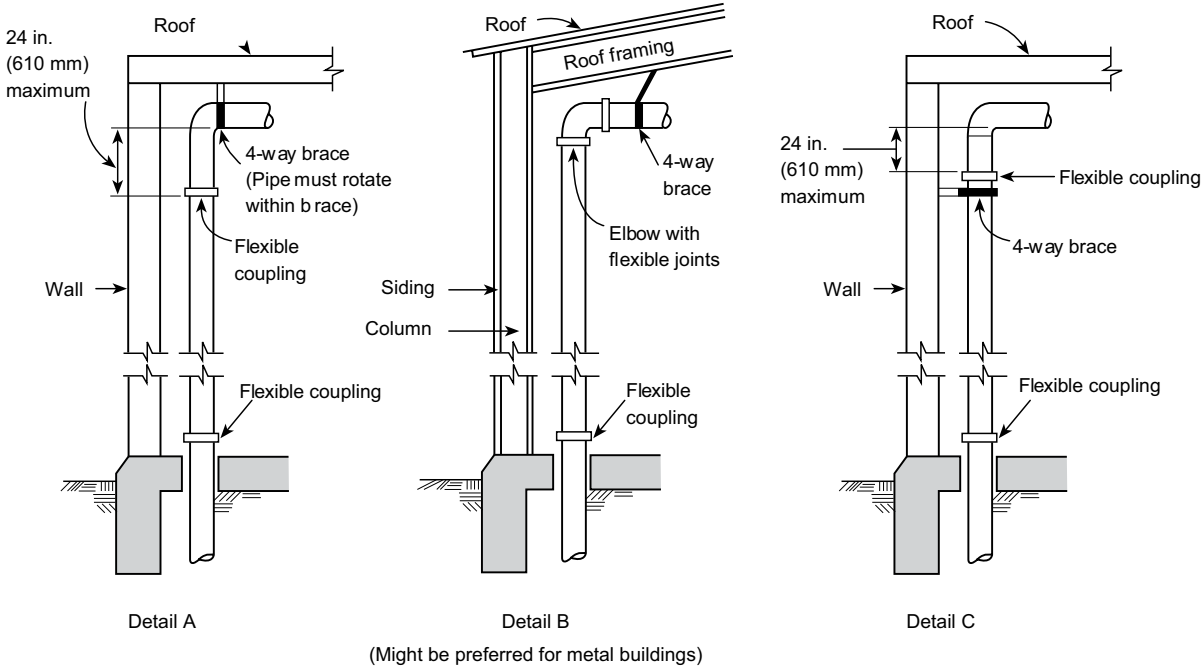

Note to Detail A: The four-way brace should be attached above the upper flexible coupling required for the riser and preferably to the roof structure if suitable. The brace should not be attached directly to a plywood or metal deck.

FIGURE A.9.3.2(a) Riser Details

2. FLEXIBLE COUPLINGS ON HORIZONTAL PORTION OF TIE-IN

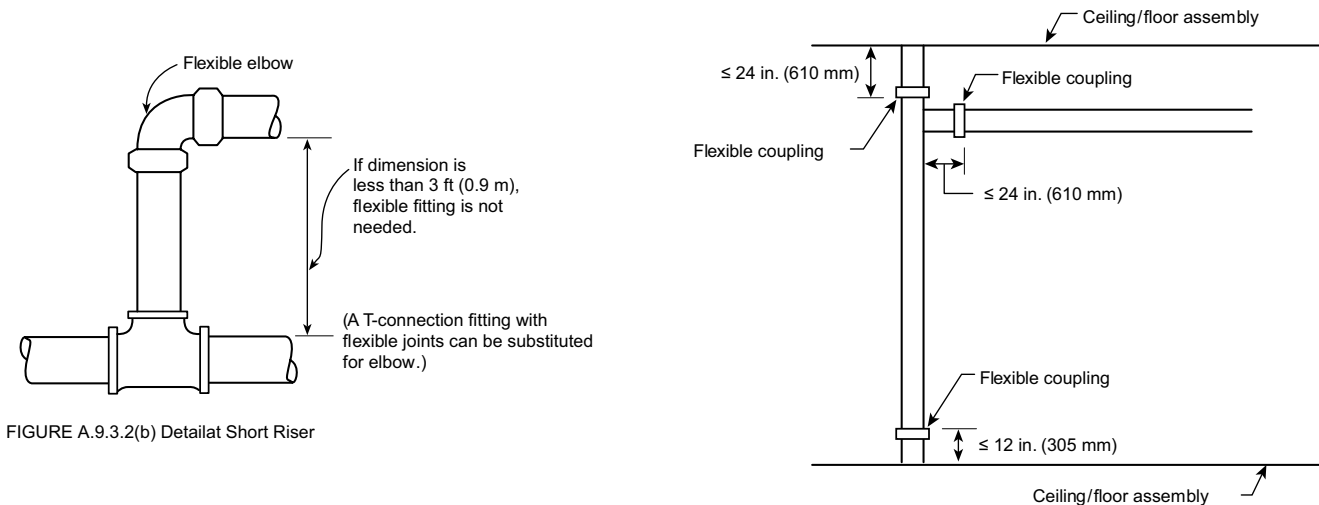

FIGURE A.9.3.2(2) Flexible Coupling on Horizontal Portion of Tie-In

3. FLEXIBLE COUPLING ON MAIN RISER AND BRANCH LINE RISER

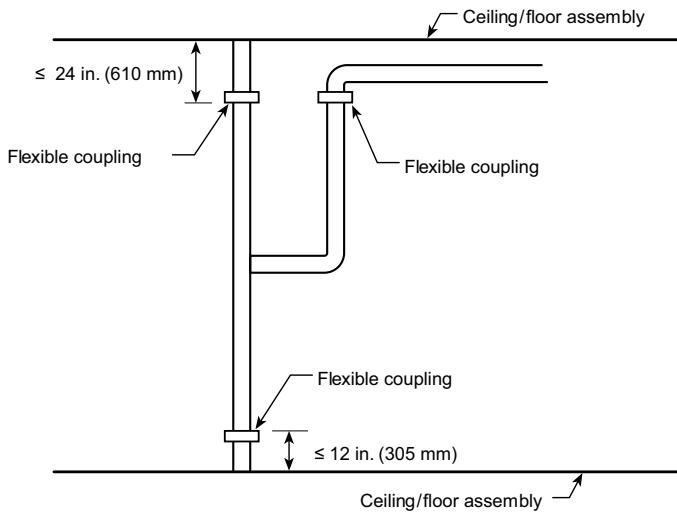

FIGURE A.9.3.2.3(2)(b) Flexible Coupling on Main Riser and Branch Line Riser

4. FLEXIBLE COUPLINGS FOR DROPS

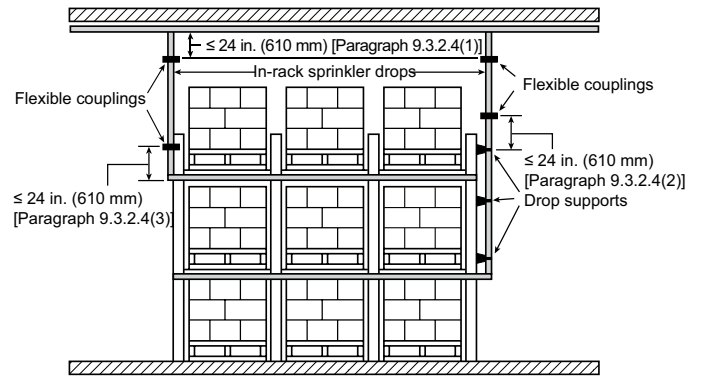
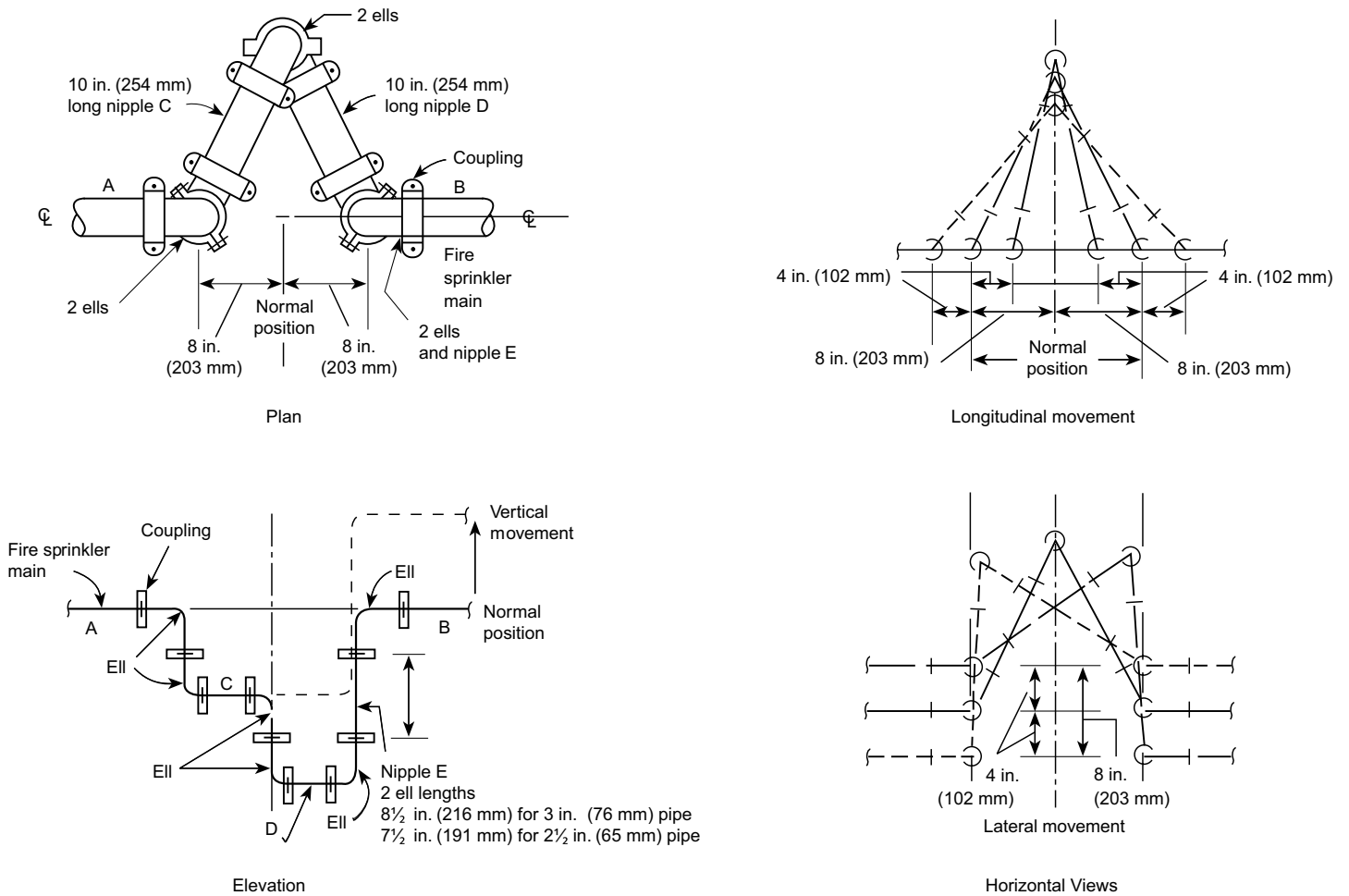
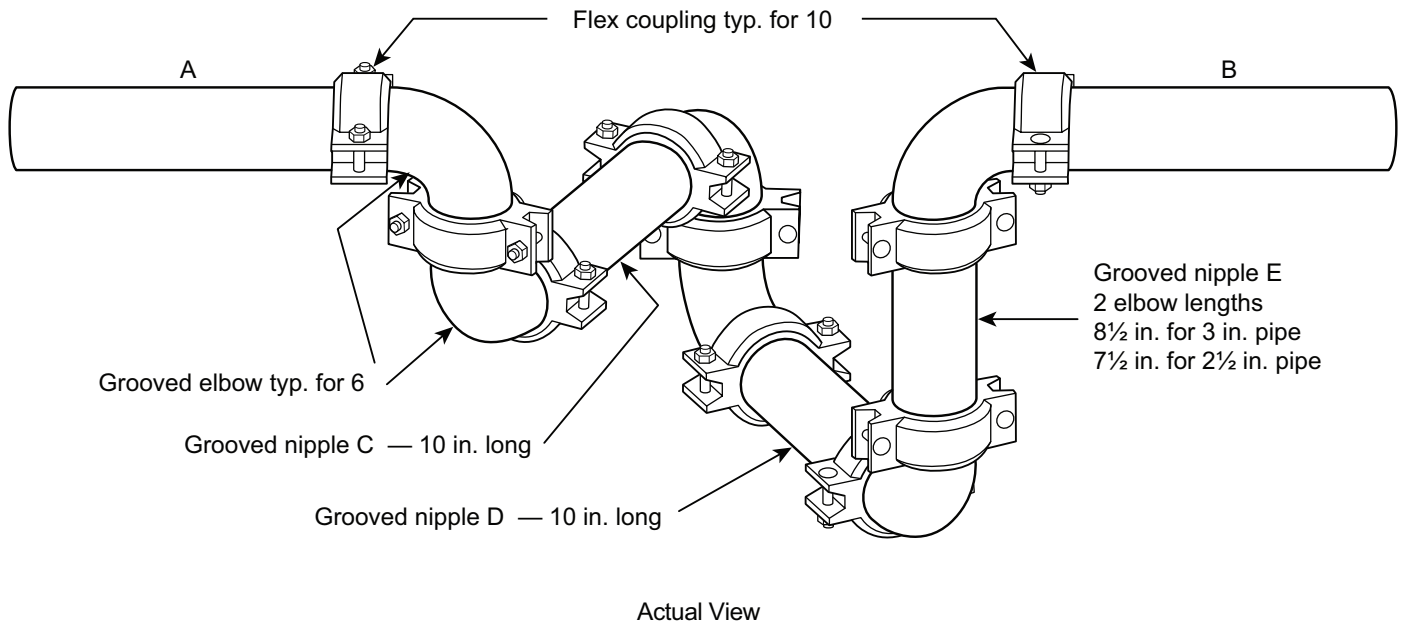

FIGURE A.9.3.2.4 Flexible Couplings for Drops

5. SEISMIC SEPARATION ASSEMBLY





6. EARTHQUAKE PROTECTION FOR SPRINKLER PIPING

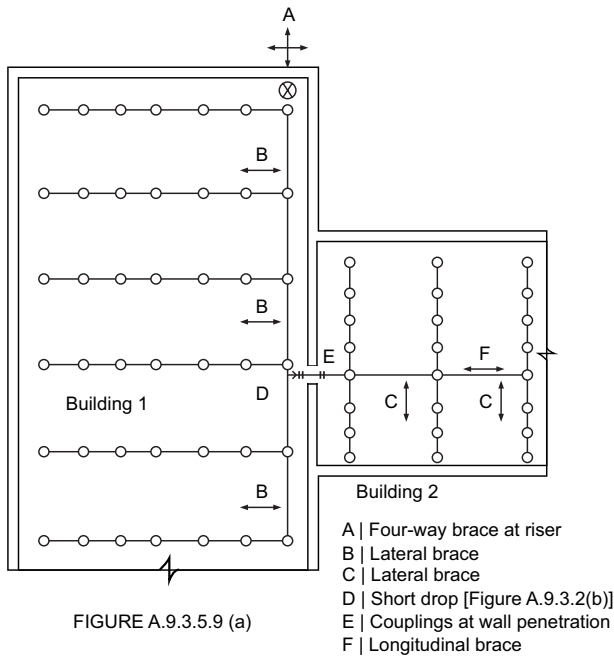

7. TYPICAL LOCATION OF BRACING ON A LOOPED SYSTEM

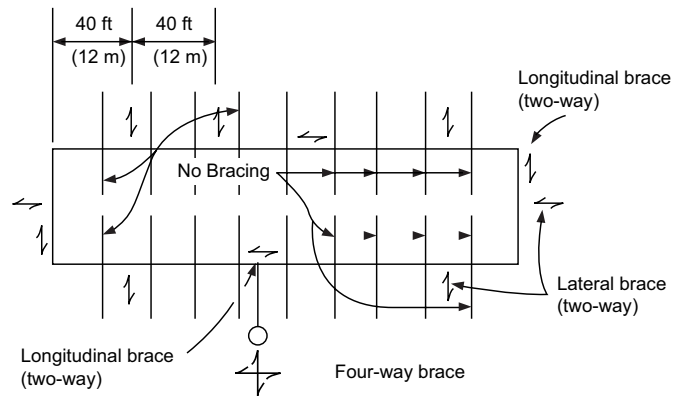

Typical Location of Bracing on a Looped System.

Systems having more flexible couplings than required above shall be provided with additional sway bracing. A lateral brace shall be provided within 24" (600 mm) of every other coupling unless pipes are supported by rods less than 6" (152 mm) long from the ceiling or by U-type hooks underside of the structural element. (NFPA 13 - 2013 9.3.2. & 9.3.5.)



[learn more](#)



www.shurjoint.com

Matthews, NC
704.841.6000



www.apollovalves.com

Regional Management List:

www.apollovalves.com/rmlist

Corporate Office	Canadian Sales Office
Matthews, NC	Concord, ON
704.841.6000	905.761.6161



www.elkhartproducts.com

Matthews, NC
704.841.6000

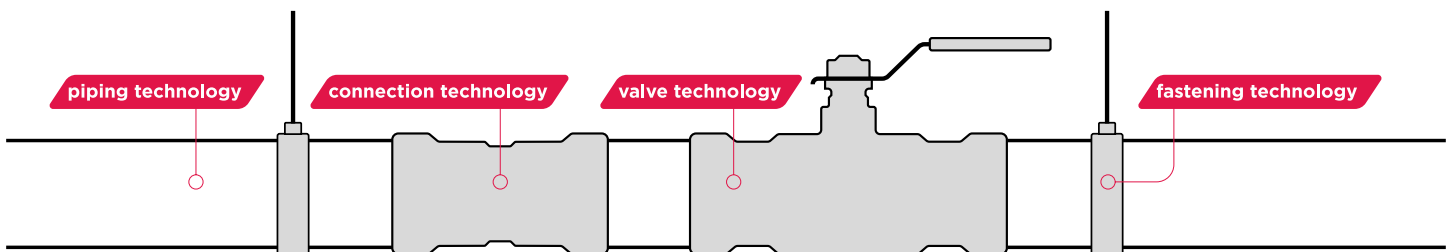

Aalberts Integrated Piping Systems

701 Matthews-Mint Hill Road
Matthews / NC / 28105 / United States
www.aalberts.com/ips

