



SANITARY SOLUTIONS^{INC.}

Bulldog Fittings/Valves...Bulldog Tough.

Sanitary Solutions Clamp Fittings



Sanitary Solutions Clamp Various Fittings are:

Clamp Fittings Stocking Alloys: T304 or T316L

Clamp Fittings Sizes: 1/2" – 12" OD Tube

Note: OD Tube and Pipe Sizes do not interchange!

Clamp Fittings Sanitary Finish: 180 Grit Polish ID/OD



Sanitary Solutions Clamp Fittings Part Number Breakdown:

<u>SS</u>	<u>Part Number</u>	<u>Size</u>	<u>Alloy</u>
Sanitary Solutions	2CMP	2"	304 or 316L

www.sanitarysolutions.com

Sanitary Solutions Inc. 1-888-909-3569 or 1-855-640-7871

Prices are subject to change without notice; please call before you quote



SS2CMP---- 90° Clamp Elbow, Polish ID/OD						
Tube OD (Size)	A	R	Weight	Part Number 304 SS		Part Number 316L SS
1/2"	1.625	1.125	0.31			SS2CMP-0.50-316L
3/4"	1.625	1.125	0.33			SS2CMP-0.75-316L
1"	2.000	1.500	0.35	SS2CMP-1-304		SS2CMP-1-316L
1.5"	2.750	2.250	0.44	SS2CMP-1.5-304		SS2CMP-1.5-316L
2"	3.500	3.000	0.81	SS2CMP-2-304		SS2CMP-2-316L
2.5"	4.250	3.750	1.00	SS2CMP-2.5-304		SS2CMP-2-316L
3"	5.000	4.500	2.00	SS2CMP-3-304		SS2CMP-3-316L
4"	6.625	6.000	3.66	SS2CMP-4-304		SS2CMP-4-316L
6"	9.875	9.000	12.10	SS2CMP-6-304		SS2CMP-6-316L
8"	12.88	12.000	17.00	SS2CMP-8-304		SS2CMP-8-316L
10"	15.88	15.000	27.50	SS2CMP-10-304		SS2CMP-10-316L
12"	18.88	18.000	30.00	SS2CMP-12-304		SS2CMP-12-316L



SS2CMP31MP-- 90° Non Tapered Reducing Clamp Elbow, Polish ID/OD						
Tube OD (Size)	A	B	Weight	Part Number 304 SS		Part Number 316L SS
2" x 1"	2.000	2.000	1.00	SS2CMP31MP-2 x 1-304		SS2CMP31MP-2 x 1-316L
2" x 1.5"	2.750	2.750	1.00	SS2CMP31MP-2 x 1.5-304		SS2CMP31MP-2 x 1.5-316L
2.5" x 1.5"	2.750	2.750	1.26	SS2CMP31MP-2.5 x 1.5-304		SS2CMP31MP-2.5 x 1.5-316L
2.5" x 2"	3.500	3.500	1.35	SS2CMP31MP-3 x 1.5-304		SS2CMP31MP-3 x 1.5-316L
3" x 1.5"	2.750	2.750	2.00	SS2CMP31MP-3 x 1.5-304		SS2CMP31MP-3 x 1.5-316L
3" x 2"	3.500	3.500	2.10	SS2CMP31MP-3 x 2-304		SS2CMP31MP-3 x 2-316L
3" x 2.5"	4.250	4.250	2.26	SS2CMP31MP-3 x 2.5-304		SS2CMP31MP-3 x 2.5-316L
4" x 2.5"	4.250	4.250	3.80	SS2CMP31MP-4 x 2.5-304		SS2CMP31MP-4 x 2.5-316L
4" x 3"	5.000	5.125	3.90	SS2CMP31MP-4 x 3-304		SS2CMP31MP-4 x 3-316L



SS2FMP-14-- 90° Clamp by Plain Bevel Seat Ferrule w/ 304 Hex Nut, Polish ID/OD						
Tube OD (Size)	A	B	Weight	Part Number 304 SS		Part Number 316L SS
1"	2.000	2.218	0.75	SS2FMP-14-1-304		SS2FMP-14-1-316L
1.5"	2.750	2.968	1.19	SS2FMP-14-1.5-304		SS2FMP-14-1.5-316L
2"	3.500	3.750	2.00	SS2FMP-14-2-304		SS2FMP-14-2-316L
2.5"	4.250	5.375	2.56	SS2FMP-14-2.5-304		SS2FMP-14-2.5-316L
3"	5.000	5.406	4.25	SS2FMP-14-3-304		SS2FMP-14-3-316L
4"	6.625	7.031	8.56	SS2FMP-14-4-304		SS2FMP-14-4-316L

www.sanitarsolutions.com

Sanitary Solutions Inc. 1-888-909-3569 or 1-855-640-7871

Prices are subject to change without notice; please call before you quote

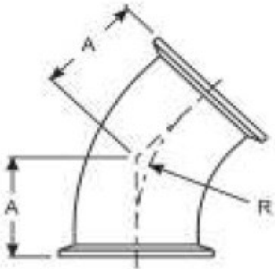

SS2KMP-- 45° Clamp Elbows, Polish ID/OD						
Tube OD (Size)	A	R	Weight	Part Number 304 SS	Part Number 316L SS	
1/2"	0.966	1.125	0.22		SS2KMP-0.50-316L	
3/4"	0.966	1.125	0.24		SS2KMP-0.75-316L	
1"	1.125	1.500	0.24	SS2KMP-1-304	SS2KMP-1-316L	
1.5"	1.437	2.250	0.31	SS2KMP-1.5-304	SS2KMP-1.5-316L	
2"	1.750	3.000	0.50	SS2KMP-2-304	SS2KMP-2-316L	
2.5"	2.062	3.750	0.57	SS2KMP-2.5-304	SS2KMP-2.5-316L	
3"	2.375	4.500	1.19	SS2KMP-3-304	SS2KMP-3-316L	
4"	3.125	6.000	2.25	SS2KMP-4-304	SS2KMP-4-316L	
6"	4.625	9.000	7.80	SS2KMP-6-304	SS2KMP-6-316L	
8"	5.875	12.000	12.40	SS2KMP-8-304	SS2KMP-8-316L	
10"	7.125	15.000	15.00	SS2KMP-10-304	SS2KMP-10-316L	
12"	8.375	18.000	17.00	SS2KMP-12-304	SS2KMP-12-316L	

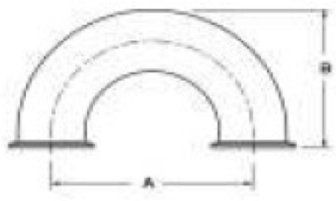

SS2WUMP-- Clamp 180° Return Bend, Polish ID/OD						
Tube OD (Size)	A	B	Weight	Part Number 304 SS	Part Number 316L SS	
1"	3.000	2.500	0.51	SS2WUMP-1-304	SSWUMP-1-316L	
1.5"	4.500	3.500	0.89	SS2WUMP-1.5-304	SSWUMP-1.5-316L	
2"	6.000	4.500	1.49	SS2WUMP-2-304	SSWUMP-2-316L	
2.5"	7.500	5.500	2.09	SS2WUMP-2.5-304	SSWUMP-2.5-316L	
3"	9.000	6.500	2.99	SSWUMP-3-304	SSWUMP-3-316L	
4"	12.000	8.625	6.35	SSWUMP-4-304	SSWUMP-4-316L	

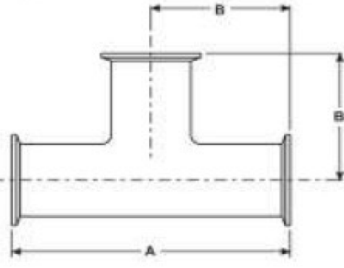

SS7MP--- Clamp Tee, Polish ID/OD						
Tube OD (Size)	A	B	Weight	Part Number 304 SS	Part Number 316L SS	
1/2"	4.750	2.375	0.40		SS7MP-0.50-316L	
3/4"	4.750	2.375	0.40		SS7MP-0.75-316L	
1"	4.750	2.375	0.33	SS7MP-1-304	SS7MP-1-316L	
1.5"	5.500	2.750	0.63	SS7MP-1.5-304	SS7MP-1.5-316L	
2"	7.000	3.500	1.35	SS7MP-2-304	SS7MP-2-316L	
2.5"	7.000	3.500	1.50	SS7MP-2.5-304	SS7MP-2.5-316L	
3"	7.500	3.750	2.45	SS7MP-3-304	SS7MP-3-316L	
4"	9.000	4.500	3.80	SS7MP-4-304	SS7MP-4-316L	
6"	13.00	6.500	11.90	SS7MP-6-304	SS7MP-6-316L	
8"	15.75	7.875	15.50	SS7MP-8-304	SS7MP-8-316L	
10"	18.75	9.375	24.00	SS7MP-10-304	SS7MP-10-316L	
12"	21.75	10.375	25.00	SS7MP-12-304	SS7MP-12-316L	

www.sanitarysolutions.com

Sanitary Solutions Inc. 1-888-909-3569 or 1-855-640-7871

Prices are subject to change without notice; please call before you quote

SS7RMP--- Clamp Reducing Tee, Polish ID/OD							
Tube OD (Size)	A	B	C	Weight	Part Number 304 SS	Part Number 316L SS	
3/4" x 1/2"	5.000	2.500	2.38	0.38		SS7RMP-0.75 x 0.50-316L	
1" x 1/2"	5.250	2.625	2.38	0.60		SS7RMP-1 x 0.50-316L	
1" x 3/4"	5.250	2.625	2.38	0.60		SS7RMP-1 x 0.75-316L	
1.5" x 1/2"	5.750	2.875	2.38	0.60		SS7RMP-1.5 x 0.50-316L	
1.5" x 3/4"	5.750	2.875	2.38	0.70		SS7RMP-1.5 x 0.75-316L	
1.5" x 1"	4.312	2.156	1.88	1.25	SS7RMP-1.5 x 1-304	SS7RMP-1.5 x 1-316L	
2" x 1/2"	5.125	2.562	1.00	1.00	SS7RMP-2 x 1/2-304	SS7RMP-2 x 1/2-304	
2" x 3/4"	5.125	2.562	1.00	1.00	SS7RMP-2 x 3/4-304	SS7RMP-2 x 3/4-304	
2" x 1"	5.125	2.562	2.13	1.35	SS7RMP-2 x 1-304	SS7RMP-2 x 1-316L	
2" x 1.5"	5.125	2.562	2.41	1.38	SS7RMP-2 x 1.5-304	SS7RMP-2 x 1.5-316L	
2.5" x 1.5"	5.688	2.844	2.66	1.48	SS7RMP-2.5 x 1.5-304	SS7RMP-2.5 x 1.5-316L	
2.5" x 2"	5.688	2.844	2.81	1.59	SS7RMP-2.5 x 2-304	SS7RMP-2.5 x 2-316L	
3" x 1"	6.188	3.093	1.44	2.40	SS7RMP-3 x 1-304	SS7RMP-3 x 1-316L	
3" x 1.5"	6.188	3.093	2.91	2.80	SS7RMP-3 x 1.5-304	SS7RMP-3 x 1.5-316L	
3" x 2"	6.188	3.093	3.06	2.50	SS7RMP-3 x 2-304	SS7RMP-3 x 2-316L	
3" x 2.5"	6.188	3.093	3.09	2.50	SS7RMP-3 x 2.5-304	SS7RMP-3 x 2.5-316L	
4" x 2"	8.125	4.063	3.56	3.36	SS7RMP-4 x 2-304	SS7RMP-4 x 2-316L	
4" x 2.5"	8.125	4.063	3.59	3.31	SS7RMP-4 x 2.5-304	SS7RMP-4 x 2.5-316L	
4" x 3"	8.125	4.063	3.59	3.67	SS7RMP-4 x 3-304	SS7RMP-4 x 3-316L	
6" x 3"	12.63	6.315	6.13	7.75	SS7RMP-6 x 3-304	SS7RMP-6 x 3-316L	
6" x 4"	12.75	6.375	6.38	7.86	SS7RMP-6 x 4-304	SS7RMP-6 x 4-316L	
8" x 4"	15.75	7.875	6.75	15.00	SS7RMP-8 x 4-304	SS7RMP-8 x 4-316L	
8" x 6"	15.75	7.875	7.50	16.50	SS7RMP-8 x 6-304	SS7RMP-8 x 6-316L	

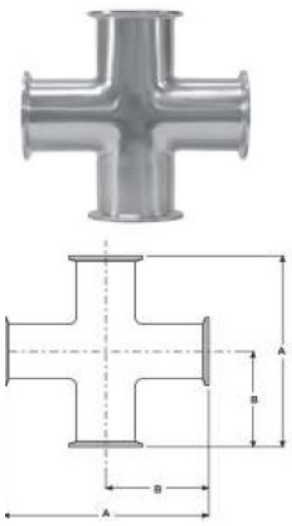
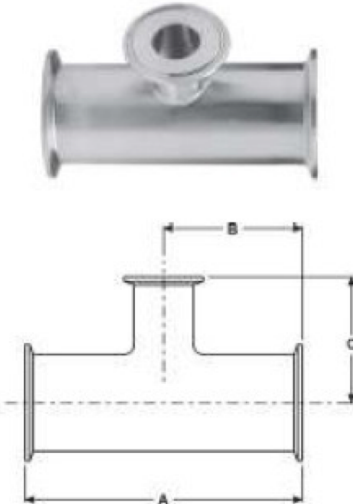

SS9MP--- Clamp Cross, Polish ID/OD						
Tube OD (Size)	A	B	Weight	Part Number 304 SS	Part Number 316L SS	
1"	4.750	2.375	1.00	SS9MP-1-304	SS9MP-1-316L	
1.5"	5.500	2.750	1.00	SS9MP-1.5-304	SS9MP-1.5-316L	
2"	7.000	3.500	1.50	SS9MP-2-304	SS9MP-2-316L	
2.5"	7.000	3.500	2.00	SS9MP-2.5-304	SS9MP-2.5-316L	
3"	7.500	3.750	2.50	SS9MP-3-304	SS9MP-3-316L	
4"	9.000	4.500	4.00	SS9MP-4-304	SS9MP-4-316L	

www.sanitarysolutions.com

Sanitary Solutions Inc. 1-888-909-3569 or 1-855-640-7871

Prices are subject to change without notice; please call before you quote



SS13MHM---Heavy Duty Single Pin Clamp With Open Hole Wing Nut						
<u>Tube OD (Size)</u>	<u>A</u>	<u>PR @ 70° F *</u>	<u>Weight</u>	<u>Box QTY.</u>	<u>Part Number 304 SS</u>	<u>BOX QUANTITY</u>
1/2"-- 3/4"	1.062	1500.00	0.41	100	SS13MHM-050-075-304	100 pieces
1"-- 1.5"	2.122	500.00	0.61	100	SS13MHM-1-1.5-304	100 pieces
2"	2.654	450.00	0.72	100	SS13MHM-2-304	100 pieces
2.5"	3.185	400.00	0.83	50	SS13MHM-2.5-304	80 pieces
3"	3.717	350.00	1.05	50	SS13MHM-3-304	70 pieces
4"	4.820	300.00	1.22	50	SS13MHM-4-304	40 pieces
5"	5.820	225.00	2.10	25	SS13MHM-5-304	1 piece
6"	6.695	150.00	2.72	20	SS13MHM-6-304	10 pieces
8"	8.695	100.00	3.33	10	SS13MHM-8-304	8 pieces
10"	10.74	100.00	5.25	10	SS13MHM-10-304	1 piece
12"	12.74	75.00	6.50	10	SS13MHM-12-304	1 piece

** Pressure Rating, Tighten Wing Nut to 25 in. lb. of torque*



SS13MHM-DP-- Heavy Duty Double Pin Clamp, With Open Hole Wing Nut				
<u>Tube OD (Size)</u>	<u>A</u>	<u>PR @ 70° F *</u>	<u>Weight</u>	<u>Part Number 304 SS</u>
1"-- 1.5"	2.122	500.00	0.61	SS13MHMDP-1-1.5-304
2"	2.654	450.00	0.72	SS13MHMDP-2-304
2.5"	3.185	400.00	0.83	SS13MHMDP-2.5-304
3"	3.717	350.00	1.05	SS13MHMDP-3-304
4"	4.820	300.00	1.22	SS13MHMDP-4-304

** Pressure Rating, Tighten Wing Nut to 25 in. lb. of torque*



SS13MHM-3P-- Heavy Duty Three Segment Clamp, With Open Hole Wing Nut				
<u>Tube OD (Size)</u>	<u>A</u>	<u>PR @ 70° F *</u>	<u>Weight</u>	<u>Part Number 304 SS</u>
1"-- 1.5"	2.122	500.00	0.80	SS13MHM3P-1-1.5-304
2"	2.654	450.00	0.60	SS13MHM3P-2-304
2.5"	3.185	400.00	0.70	SS13MHM3P-2.5-304
3"	3.717	350.00	0.80	SS13MHM3P-3-304
4"	4.820	300.00	0.90	SS13MHM3P-4-304

** Pressure Rating, Tighten Wing Nut to 25 in. lb. of torque*

www.sanitarysolutions.com

Sanitary Solutions Inc. 1-888-909-3569 or 1-855-640-7871

Prices are subject to change without notice; please call before you quote

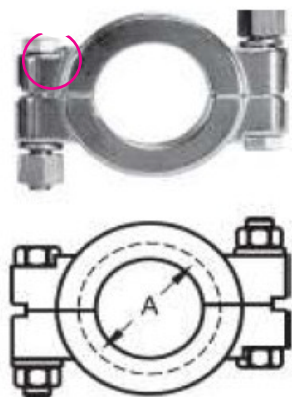

SS13MHP-- Heavy Duty Bolted Clamp, With Open Hole Wing Nut				
<u>Tube OD (Size)</u>	<u>A</u>	<u>PR @ 70° F *</u>	<u>Weight</u>	<u>Part Number</u> 304 SS
1/2"-- 3/4"	1.062	1500	0.44	SS13MHP-050-075-304
1"-- 1.5"	2.046	1500	0.77	SS13MHP-1-1.5-304
2"	2.578	1000	0.86	SS13MHP-2-304
2.5"	3.110	1000	0.97	SS13MHP-2.5-304
3"	3.460	1000	1.12	SS13MHP-3-304
4"	4.744	800	1.42	SS13MHP-4-304
6"	6.632	300	2.81	SS13MHP-6-304
8"	8.638	250	3.00	SS13MHP-8-304
10"	10.740	200	4.40	SS13MHP-10-304

** Pressure Rating, Tighten Bronze Nut to 20 Ft. lb. of torque*

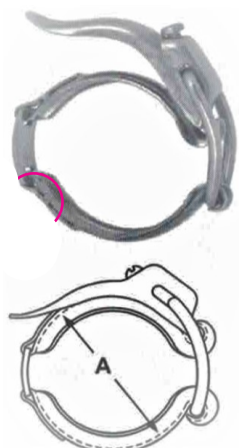

SS13MHLA -- Adjustable Light Duty Toggle Clamp NEW!!!				
<u>Tube OD (Size)</u>	<u>A</u>	<u>PR @ 70° F *</u>	<u>Weight</u>	<u>Part Number</u> 304 SS
1"-- 1.5"	2.122	150	0.61	SS13MHLA-1-1.5-304
2"	2.654	150	0.72	SS13MHLA-2-304
2.5"	3.185	150	0.83	SS13MHLA-2.5-304
3"	3.717	150	1.05	SS13MHLA-3-304
4"	4.820	100	1.22	SS13MHLA-4-304

** Pressure Rating*



SS13OHWN-- Open Hole Wing Nut			
<u>(Size)</u>	<u>Weight</u>		<u>Part Number</u> 304 SS
OSFA	0.10		SS13OHWN

One Size Fits All



SS13SWN-- Serrated Wing Nut			
<u>(Size)</u>	<u>Weight</u>		<u>Part Number</u> 304 SS
OSFA	0.10		SS13SWN

One Size Fits All

www.sanitarysolutions.com

Sanitary Solutions Inc. 1-888-909-3569 or 1-855-640-7871

Prices are subject to change without notice; please call before you quote

SS14WMP-- <u>Short</u> Welding Ferrule							
Tube OD (Size)	A	B	C	Weight	Part Number 304 SS	Part Number 316L SS	
1/2"	0.500	0.370	0.500	0.04		SS14WMP-0.50-316L	
3/4"	0.500	0.620	0.750	0.05		SS14WMP-0.75-316L	
1"	0.500	0.870	1.000	0.12	SS14WMP-1-304	SS14WMP-1-316L	
1.5"	0.500	1.370	1.500	0.13	SS14WMP-1.5-304	SS14WMP-1.5-316L	
2"	0.500	1.870	2.000	0.22	SS14WMP-2-304	SS14WMP-2-316L	
2.5"	0.500	2.370	2.500	0.26	SS14WMP-2.5-304	SS14WMP-2.5-316L	
3"	0.500	2.870	3.000	0.33	SS14WMP-3-304	SS14WMP-3-316L	
4"	0.625	3.834	4.000	0.57	SS14WMP-4-304	SS14WMP-4-316L	
5"	0.750	4.782	5.000	0.57	SS14WMP-5-304	SS14WMP-5-316L	
6"	0.875	5.782	6.000	0.42	SS14WMP-6-304	SS14WMP-6-316L	
8"	0.875	7.782	8.000	1.25	SS14WMP-8-304	SS14WMP-8-316L	
10"	0.875	9.782	10.00	2.00	SS14WMP-10-304	SS14WMP-10-316L	
12"	0.875	11.760	12.00	2.00	SS14WMP-12-304	SS14WMP-12-316L	



SSL14AM7-- <u>Long</u> Butt Weld Ferrule							
Tube OD (Size)	A	B	C	Weight	Part Number 304 SS	Part Number 316L SS	
1/2"	1.125	0.370	0.500	0.04		SSL14AM7-0.50-316L	
3/4"	1.125	0.620	0.750	0.04		SSL14AM7-0.75-316L	
1"	1.125	0.870	1.000	0.09	SSL14AM7-1-304	SSL14AM7-1-316L	
1.5"	1.125	1.370	1.500	0.13	SSL14AM7-1.5-304	SSL14AM7-1.5-316L	
2"	1.125	1.870	2.000	0.20	SSL14AM7-2-304	SSL14AM7-2-316L	
2.5"	1.125	2.370	2.500	0.25	SSL14AM7-2.5-304	SSL14AM7-2.5-316L	
3"	1.125	2.870	3.000	0.31	SSL14AM7-3-304	SSL14AM7-3-316L	
4"	1.125	3.834	4.000	0.56	SSL14AM7-4-304	SSL14AM7-4-316L	
5"	1.125	4.782	5.000	0.90	SSL14AM7-5-304	SSL14AM7-5-316L	
6"	1.500	5.782	6.000	1.20	SSL14AM7-6-304	SSL14AM7-6-316L	
8"	1.500	7.782	8.000	1.75	SSL14AM7-8-304	SSL14AM7-8-316L	
10"	1.750	9.782	10.00	3.00	SSL14AM7-10-304	SSL14AM7-10-316L	
12"	1.750	11.760	12.00	3.00	SSL14AM7-12-304	SSL14AM7-12-316L	



www.sanitarysolutions.com

Sanitary Solutions Inc. 1-888-909-3569 or 1-855-640-7871

Prices are subject to change without notice; please call before you quote

SS14MPHR-- Clamp <i>Rubber Hose Barb</i> Adapter					
Tube OD (Size)	A	B	Weight	Part Number 304 SS	Part Number 316L SS
1/2" x 1/8"	1.250	0.125	NA		SS14MPHR- 1/2 - 1/8- 316L
1/2" x 1/4"	1.500	0.250	NA		SS14MPHR- 1/2 - 1/4- 316L
1/2" x 3/8"	1.500	0.375	NA		SS14MPHR- 1/2 - 3/8- 316L
1/2" x 1/2"	1.500	0.500	0.10		SS14MPHR- 1/2 - 316L
1/2" x 3/4"	1.500	0.750	NA		SS14MPHR- 1/2 - 3/4- 316L
3/4" x 1/8"	1.500	0.125	NA		SS14MPHR- 3/4 - 1/8- 316L
3/4" x 1/4"	1.500	0.250	NA		SS14MPHR- 3/4 - 1/4- 316L
3/4" x 3/8"	1.500	0.375	NA		SS14MPHR- 3/4 - 3/8- 316L
3/4" x 1/2"	1.500	0.500	NA		SS14MPHR- 3/4 - 1/2- 316L
3/4" x 3/4"	1.500	0.750	0.11		SS14MPHR- 3/4 - 316L
1" x 1"	1.688	1.000	0.15	SS14MPHR-1-304	SS14MPHR-1-316L
1" x 3/8"	1.500	0.375	NA	SS14MPHR-1 x 3/8-304	SS14MPHR-1 x 3/8-316L
1" x 1/2"	1.500	0.500	NA	SS14MPHR-1 x 1/2-304	SS14MPHR-1 x 1/2-316L
1" x 3/4"	1.500	0.750	NA	SS14MPHR-1 x 3/4-304	SS14MPHR-1 x 3/4-316L
1.5" x 1/8"	1.500	0.125	NA	SS14MPHR-1.5 x 1/8-304	SS14MPHR-1.5 x 1/8-316L
1.5" x 1/4"	1.500	0.250	NA	SS14MPHR-1.5 x 1/4-304	SS14MPHR-1.5 x 1/4-316L
1.5" x 3/8"	1.500	0.375	NA	SS14MPHR-1.5 x 3/8-304	SS14MPHR-1.5 x 3/8-316L
1.5" x 1/2"	1.500	0.500	0.58	SS14MPHR-1.5 x 1/2-304	SS14MPHR-1.5 x 1/2-316L
1.5" x 3/4"	1.500	0.750	0.58	SS14MPHR-1.5 x 3/4-304	SS14MPHR-1.5 x 3/4-316L
1.5" x 1"	1.688	1.000	0.83	SS14MPHR-1.5 x 1-304	SS14MPHR-1.5 x 1-316L
1.5" x 1.5"	1.688	1.500	NA	SS14MPHR-1.5-304	SS14MPHR-1.5-316L
2" x 1.5"	2.312	1.500	NA	SS14MPHR-2 x 1.5-304	SS14MPHR-2 x 1.5-316L
2" x 2"	2.313	2.000	1.01	SS14MPHR-2-304	SS14MPHR-2-316L
2.5" x 2.5"	2.344	2.500	0.83	SS14MPHR-2.5-304	SS14MPHR-2.5-316L
3" x 3"	3.094	3.000	1.15	SS14MPHR-3-304	SS14MPHR-3-316L
4" x 4"	3.406	4.000	1.55	SS14MPHR-4-304	SS14MPHR-4-316L
6" x 6"	4.500	6.000	NA	SS14MPHR-6-304	SS14MPHR-6-316L
8" x 8"	4.500	8.000	NA	SS14MPHR-8-304	SS14MPHR-8-316L

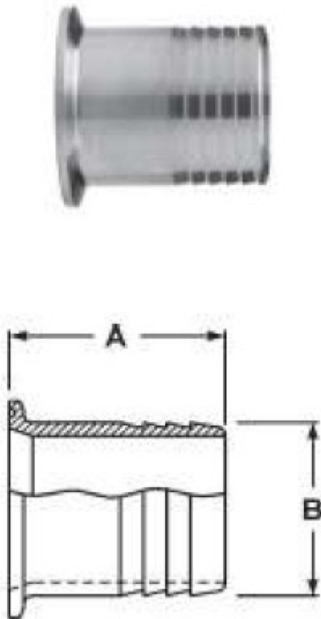

www.sanitarysolutions.com

Sanitary Solutions Inc. 1-888-909-3569 or 1-855-640-7871

Prices are subject to change without notice; please call before you quote

SS14MPHRL-- LONG Clamp Rubber Hose Barb Adapter

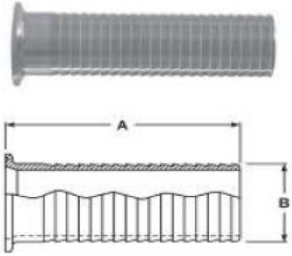

Tube OD (Size)	A	B	Weight	Part Number 304 SS	Part Number 316L SS
1"	3.500	1.045	0.30	SS14MPHRL-1-304	SS14MPHRL-1-316L
1.5"	5.000	1.545	0.50	SS14MPHRL-1.5-304	SS14MPHRL-1.5-316L
2"	5.000	2.045	0.75	SS14MPHRL-2-304	SS14MPHRL-2-316L
2.5"	5.500	2.545	1.38	SS14MPHRL-2.5-304	SS14MPHRL-2.5-316L
3"	5.500	3.045	1.19	SS14MPHRL-3-304	SS14MPHRL-3-316L
4"	5.500	4.045	2.00	SS14MPHRL-4-304	SS14MPHRL-4-316L

SS14MPHT-- Clamp Tygon® Hose Adapter

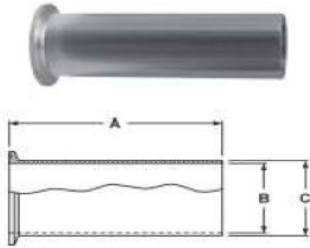

Tube OD (Size)	A	B	C	Weight	Part Number 304 SS	Part Number 316L SS
1/2"	4.000	0.370	0.500	CALL		SS14MPHT-0.50-316L
3/4"	4.000	0.620	0.750	CALL		SS14MPHT-0.75-316L
1"	4.500	0.870	1.000	0.10	SS14MPHT-1-304	SS14MPHT-1-316L
1.5"	4.500	1.370	1.500	0.10	SS14MPHT-1.5-304	SS14MPHT-1.5-316L
2"	4.500	1.870	2.000	0.50	SS14MPHT-2-304	SS14MPHT-2-316L
2.5"	4.500	2.370	2.500	0.50	SS14MPHT-2.5-304	SS14MPHT-2.5-316L
3"	4.500	2.870	3.000	1.00	SS14MPHT-3-304	SS14MPHT-3-316L
4"	4.625	3.834	4.000	1.50	SS14MPHT-4-304	SS14MPHT-4-316L
6"	6.000	5.782	6.000	3.90	SS14MPHT-6-304	SS14MPHT-6-316L
8"	6.000	7.782	8.000	3.90	SS14MPHT-8-304	SS14MPHT-8-316L

SS14MPW-- Heavy Wall Tank Weld Ferrule

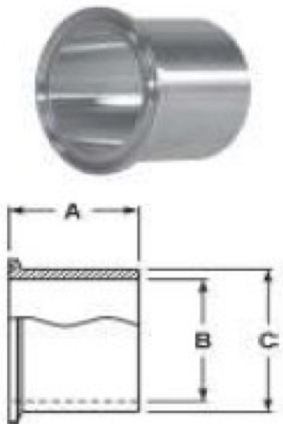



Tube OD (Size)	A	B	C	Weight	Part Number 304 SS	Part Number 316L SS
1/2"	1.625	0.321	0.502	0.04		SS14MPW-0.50-316L
3/4"	1.625	0.574	0.750	0.05		SS14MPW-0.75-316L
1"	1.625	0.870	1.160	0.12	SS14MPW-1-304	SS14MPW-1-316L
1.5"	1.625	1.370	1.676	0.13	SS14MPW-1.5-304	SS14MPW-1.5-316L
2"	1.750	1.870	2.192	0.22	SS14MPW-2-304	SS14MPW-2-316L
2.5"	1.750	2.370	2.708	0.26	SS14MPW-2.5-304	SS14MPW-2.5-316L
3"	1.813	2.870	3.224	0.33	SS14MPW-3-304	SS14MPW-3-316L
4"	2.125	3.834	4.256	0.57	SS14MPW-4-304	SS14MPW-4-316L
6"	2.500	5.758	6.262	0.42	SS14MPW-6-304	SS14MPW-6-316L
8"	2.500	7.758	8.262	1.25	SS14MPW-8-304	SS14MPW-8-316L

www.sanitarysolutions.com

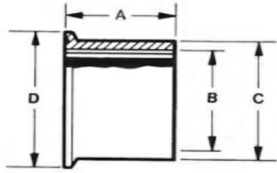

Sanitary Solutions Inc. 1-888-909-3569 or 1-855-640-7871

Prices are subject to change without notice; please call before you quote

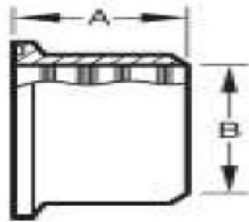

SS14MPWL-- Long Heavy Wall Tank Weld Ferrule						
Tube OD (Size)	A	B	C	Weight	Part Number 304 SS 	Part Number 316L SS 
1"	3.000	0.870	1.160	0.18	SS14MPWL-1-304	SS14MPWL-1-316L <i>NEW!</i>
1.5"	3.000	1.370	1.676	0.25	SS14MPWL-1.5-304	SS14MPWL-1.5-316L
2"	3.000	1.870	2.192	0.45	SS14MPWL-2-304	SS14MPWL-2-316L
2.5"	3.000	2.370	2.708	0.59	SS14MPWL-2.5-304	SS14MPWL-2.5-316L
3"	4.000	2.870	3.224	0.82	SS14MPWL-3-304	SS14MPWL-3-316L
4"	4.000	3.834	4.256	1.31	SS14MPWL-4-304	SS14MPWL-4-316L
6"	6.000	5.758	6.192	2.06	SS14MPWL-6-304	SS14MPWL-6-316L



SS14RMP-- Roll-On Expanding Ferrule					
Tube OD (Size)	A	B	Weight	Part Number 304 SS 	Part Number 316L SS 
1"	0.750	1.005	0.13	SS14RMP-1-304	SS14RMP-1-316L
1.5"	1.125	1.505	0.13	SS14RMP-1.5-304	SS14RMP-1.5-316L
2"	1.312	2.005	0.25	SS14RMP-2-304	SS14RMP-2-316L
2.5"	1.375	2.505	0.34	SS14RMP-2.5-304	SS14RMP-2.5-316L
3"	1.437	3.005	0.47	SS14RMP-3-304	SS14RMP-3-316L
4"	1.500	4.005	0.70	SS14RMP-4-304	SS14RMP-4-316L
6"	2.000	6.005	1.40	SS14RMP-6-304	SS14RMP-6-316L

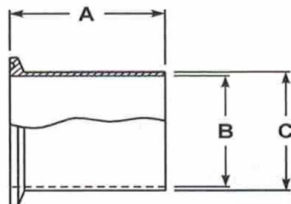

SST14AM7-- Automatic Weld Ferrule					
Tube OD (Size)	A	B	C	Weight	Part Number 316L 
1/2"	1.750	0.370	0.500	0.04	SST14AM7- 0.50-316L <i>NEW!</i>
3/4"	1.750	0.620	0.750	0.04	SST14AM7- 0.75-316L
1"	1.750	0.870	1.000	0.09	SST14AM7-1-316L
1.5"	1.750	1.370	1.500	0.13	SST14AM7-1.5-316L
2"	2.250	1.870	2.000	0.20	SST14AM7-2-316L
2.5"	2.250	2.370	2.500	0.25	SST14AM7-2.5-316L
3"	2.250	2.870	3.000	0.31	SST14AM7- 3-316L
4"	2.250	3.830	4.000	0.56	SST14AM7-4-316L
6"	3.000	5.780	6.000	1.50	SST14AM7-6-316L



www.sanitarysolutions.com

Sanitary Solutions Inc. 1-888-909-3569 or 1-855-640-7871

Prices are subject to change without notice; please call before you quote

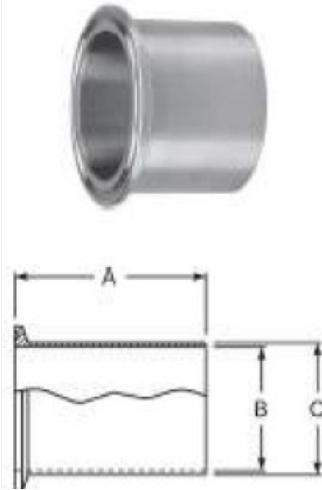

SS14WLMP-- *Light Wall* Tank Ferrule



Tube OD (Size)	A	B	C	Weight	Part Number 304 SS 	Part Number 316L 
1"	3.000	0.870	1.000	0.180	SSL14WLMP-1-304	SSL14WLMP-1-316L
1.5"	3.000	1.320	1.500	0.250	SSL14WLMP-1.5-304	SSL14WLMP-1.5-316L
2"	3.000	1.870	2.000	0.450	SSL14WLMP-2-304	SSL14WLMP-2-316L
2.5"	3.000	2.370	2.500	0.590	SSL14WLMP-2.5-304	SSL14WLMP-2.5-316L
3"	4.000	2.870	3.000	0.820	SSL14WLMP-3-304	SSL14WLMP-3-316L
4"	4.000	3.834	4.000	1.310	SSL14WLMP-4-304	SSL14WLMP-4-316L
6"	6.000	5.782	6.000	2.060	SSL14WLMP-6-304	SSL14WLMP-6-316L
8"	6.000	7.760	8.000	CALL	SSL14WLMP-8-304	SSL14WLMP-8-316L
10"	6.000	9.782	10.000	CALL	SSL14WLMP-10-304	SSL14WLMP-10-316L
12"	6.000	11.760	12.000	CALL	SSL14WLMP-12-304	SSL14WLMP-12-316L



SS16AMP-- Clamp Solid End Cap



Tube OD (Size)	A	B	Weight	Part Number 304 SS 	Part Number 316L SS 
1/2"-- 3/4"	0.187	0.992	0.03		SS16AMP-050-075-316L
1"-- 1.5"	0.250	1.984	0.15	SS16AMP-1-1.5-304	SS16AMP-1-1.5-316L
2"	0.250	2.516	0.31	SS16AMP-2-304	SS16AMP-2-316L
2.5"	0.250	3.047	0.44	SS16AMP-2.5-304	SS16AMP-2.5-316L
3"	0.250	3.579	0.90	SS16AMP-3-304	SS16AMP-3-316L
4"	0.312	4.682	1.25	SS16AMP-4-304	SS16AMP-4-316L
5"	0.312	5.687	1.85	SS16AMP-5-304	SS16AMP-5-316L
6"	0.438	6.570	3.95	SS16AMP-6-304	SS16AMP-6-316L
8"	0.438	8.570	7.06	SS16AMP-8-304	SS16AMP-8-316L
10"	0.438	10.570	10.00	SS16AMP-10-304	SS16AMP-10-316L
12"	0.438	12.670	12.00	SS16AMP-12-304	SS16AMP-12-316L

SS17MP-14--Clamp x Plain Bevel Seat Ferrule w/ (304) Hex Nut Adapter



Tube OD (Size)	A	Weight	Part Number 304 SS 	Part Number 316L SS 
1"	3.000	0.63	SS17MP-14-1-304	SS17MP-14-1-316L
1.5"	3.000	0.88	SS17MP-14-1.5-304	SS17MP-14-1.5-316L
2"	3.000	1.38	SS17MP-14-2-304	SS17MP-14-2-316L
2.5"	3.500	2.06	SS17MP-14-2.5-304	SS17MP-14-2.5-316L
3"	3.750	2.81	SS17MP-14-3-304	SS17MP-14-3-316L
4"	4.000	5.25	SSL17MP-14-4-304	SSL17MP-14-4-316L

www.sanitarysolutions.com

Sanitary Solutions Inc. 1-888-909-3569 or 1-855-640-7871

Prices are subject to change without notice; please call before you quote

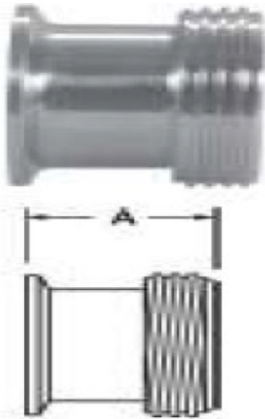

SS17MP-15--Clamp x Thread Bevel Seat Ferrule Adapter, Polish ID/OD				
Tube OD (Size)	A	Weight	Part Number 304 SS	Part Number 316L SS
1"	1.688	0.31	SS17MP-15-1-304	SS17MP-15-1-316L
1.5"	1.719	0.38	SS17MP-15-1.5-304	SS17MP-15-1.5-316L
2"	1.719	0.56	SS17MP-15-2-304	SS17MP-15-2-316L
2.5"	1.844	0.75	SS17MP-15-2.5-304	SS17MP-15-2.5-316L
3"	1.906	0.94	SS17MP-15-3-304	SS17MP-15-3-316L
4"	2.344	1.69	SSL17MP-15-4-304	SSL17MP-15-4-316L



SS21MP-- Clamp x (MNPT) Adapter					
Tube OD (Size)	A	B	Weight	Part Number 304	Part Number 316L
1/2" x 1/2"	1.625	0.782	0.35	SS21MP-1/2 x 1/2-304	SS21MP-1/2 x 1/2-316L
3/4" x 1/2"	2.000	0.782	0.35	SS21MP-3/4 x 1/2-304	SS21MP-3/4 x 1/2-316L
1" x 1/2"	2.187	0.782	0.35	SS21MP-1 x 1/2-304	SS21MP-1 x 1/2-316L
1" x 3/4"	2.187	0.794	1.00	SS21MP-1 x 3/4-304	SS21MP-1 x 3/4-316L
1" x 1"	2.250	0.985	1.00	SS21MP-1-304	SS21MP-1-316L
1.5" x 1/2"	2.187	0.782	0.48	SS21MP-1.5 x 1/2-304	SS21MP-1.5 x 1/2-316L
1.5" x 3/4"	2.187	0.794	0.80	SS21MP-1.5 x 3/4-304	SS21MP-1.5 x 3/4-316L
1.5" x 1"	2.437	0.985	0.48	SS21MP-1.5 x 1-304	SS21MP-1.5 x 1-316L
1.5" x 1.25"	2.438	1.009	0.50	SS21MP-1.5 x 1.25-304	SS21MP-1.5 x 1.25-316L
1.5" x 1.5"	2.250	1.025	0.63	SS21MP-1.5-304	SS21MP-1.5-316L
2" x 1"	2.469	0.985	0.63	SS21MP-2 x 1-304	SS21MP-2 x 1-316L
2" x 1.5"	2.625	1.009	0.63	SS21MP-2 x 1.5-304	SS21MP-2 x 1.5-316L
2" x 2"	2.638	1.058	0.63	SS21MP-2-304	SS21MP-2-316L
2.5" x 2.5"	2.875	1.571	1.50	SS21MP-2.5-304	SS21MP-2.5-316L
3" x 3"	3.070	1.634	2.00	SS21MP-3-304	SS21MP-3-316L
4" x 4"	3.155	1.734	3.50	SS21MP-4-304	SS21MP-4-316L

www.sanitarysolutions.com

Sanitary Solutions Inc. 1-888-909-3569 or 1-855-640-7871

Prices are subject to change without notice; please call before you quote

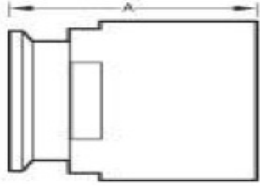

SS22MP-- Clamp x (FNPT) Adapter						
Tube OD (Size)	A	Weight	Part Number 304 SS		Part Number 316L SS	
1/2" x 1/2"	1.50	0.30			SS22MP-0.50-316L	
3/4" x 3/4"	1.625	0.30			SS22MP-0.75-316L	
1" x 1"	1.625	0.10	SS22MP-1-304		SS22MP-1-316L	
1.5" x 1.5"	2.250	0.38	SS22MP-1.5-304		SS22MP-1.5-316L	
2" x 2"	2.344	1.13	SS22MP-2-304		SS22MP-2-316L	
2.5" x 2.5"	2.093	1.00	SS22MP-2.5-304		SS22MP-2.5-316L	
3" x 3"	2.187	2.75	SS22MP-3-304		SS22MP-3-316L	
4" x 4"	3.652	3.80	SS22MP-4-304		SS22MP-4-316L	

SS23BMP-- Clamp Thermometer Cap								
Tube OD (Size)	A	B	C	Weight	Part Number 304 SS		Part Number 316L SS	
1/2"	0.500	0.993	1/4" NPT	CALL			SS23BMP- 0.50-316L	
3/4"	0.500	0.993	1/4" NPT	CALL			SS23BMP-0.75-316L	
1"	0.625	1.984	1/2" NPT	0.18	SS23BMP-1-304		SS23BMP-1-316L	
1.5"	0.625	1.984	3/4" NPT	0.25	SS23BMP-1.5-304		SS23BMP-1.5-316L	
2"	0.625	2.516	3/4" NPT	0.45	SS23BMP-2-304		SS23BMP-2-316L	
2.5"	0.625	3.047	3/4" NPT	0.59	SS23BMP-2.5-304		SS23BMP-2.5-316L	
3"	0.625	3.579	3/4" NPT	0.82	SS23BMP-3-304		SS23BMP-3-316L	
4"	0.625	4.682	3/4" NPT	1.31	SS23BMP-4-304		SS23BMP-4-316L	

**Other NPT Sizes Available*

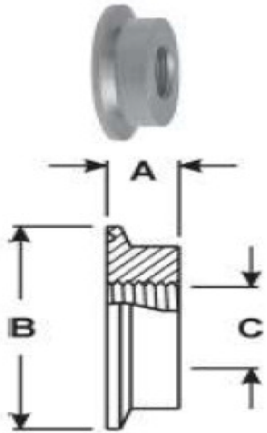

SS28LMP-- Clamp <i>Lateral "Y"</i> , Polish ID/OD								
Tube OD (Size)	A	B	C	Weight	Part Number 304 SS		Part Number 316L SS	
1"	7.000	1.500	5.50	1.10	SS28LMP-1-304		SS28LMP-1-316L	
1.5"	8.375	2.430	7.43	1.25	SS28LMP-1.5-304		SS28LMP-1.5-316L	
2"	9.750	2.125	7.63	2.10	SS28LMP-2-304		SS28LMP-2-316L	
2.5"	11.000	2.000	9.00	2.45	SS28LMP-2.5-304		SS28LMP-2.5-316L	
3"	11.750	2.375	9.38	3.15	SS28LMP-3-304		SS28LMP-3-316L	
4"	14.062	2.640	11.31	5.35	SS28LMP-4-304		SS28LMP-4-316L	
6"	18.250	5.000	16.38	20.00	SS28LMP-6-304		SS28LMP-6-316L	

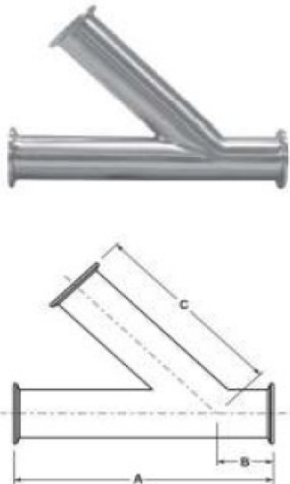

www.sanitarysolutions.com

Sanitary Solutions Inc. 1-888-909-3569 or 1-855-640-7871

Prices are subject to change without notice; please call before you quote

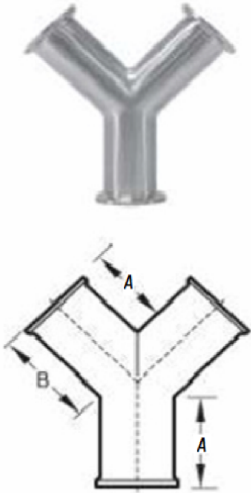

SS28YMP-- Clamp True "Y", Polish ID/OD						
Tube OD (Size)	A	B	Weight	Part Number 304 SS		Part Number 316L SS
1"	2.500	2.938	1.10	SS28YMP-1-304		SS28YMP-1-316L
1.5"	2.500	2.938	1.25	SS28YMP-1.5-304		SS28YMP-1.5-316L
2"	3.125	3.750	2.10	SS28YMP-2-304		SS28YMP-2-316L
2.5"	3.875	4.625	2.45	SS28YMP-2.5-304		SS28YMP-2.5-316L
3"	4.500	5.375	3.15	SS28YMP-3-304		SS28YMP-3-316L
4"	5.875	7.062	5.35	SS28YMP-4-304		SS28YMP-4-316L
6"	8.688	9.500	17.00	SS28YMP-6-304		SS28YMP-6-316L

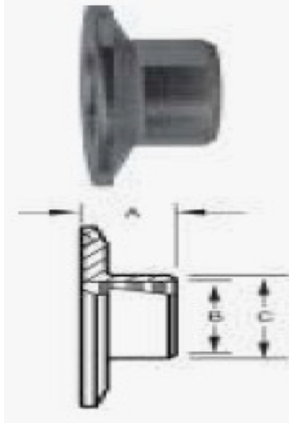

SS31RMP-- Roll-On (Reducing) Ferrule						
Tube OD (Size)	A	B	C	Weight	Part Number 304 SS	Part Number 316L SS
1.5" x 1"	0.750	1.007	1.16	CALL	SS31RMP-1.5 x 1-304	SS31RMP-1.5 x 1-316L
2" x 1"	0.750	1.007	1.16	CALL	SS31RMP-2 x 1-304	SS31RMP-2 x 1-316L
2" x 1.5"	1.125	1.507	1.68	CALL	SS31RMP-2 x 1.5-304	SS31RMP-2 x 1.5-316L
2.5" x 1.5"	1.125	1.507	1.68	CALL	SS31RMP-2.5 x 1.5-304	SS31RMP-2.5 x 1.5-316L
2.5" x 2"	1.125	2.007	2.19	CALL	SS31RMP-2.5 x 2-304	SS31RMP-2.5 x 2-316L
3" x 1.5"	1.313	1.507	1.68	CALL	SS31RMP-3 x 1.5-304	SS31RMP-3 x 1.5-316L
3" x 2"	1.313	2.007	2.19	CALL	SS31RMP-3 x 2-304	SS31RMP-3 x 2-316L
4" x 2.5"	1.375	2.507	2.69	CALL	SS31RMP-4 x 2.5-304	SS31RMP-4 x 2.5-316L
4" x 3"	1.375	3.007	3.22	CALL	SS31RMP-4 x 3-304	SS31RMP-4 x 3-316L



www.sanitarysolutions.com

Sanitary Solutions Inc. 1-888-909-3569 or 1-855-640-7871

Prices are subject to change without notice; please call before you quote

SS31-14MP--- Clamp x Clamp *Concentric* Reducer, Polish ID/OD



Tube OD (Size)	A	Weight	Part Number 304 SS		Part Number 316L SS	
3/4" x 1/2"	2.000	0.25			SS31-14MP-.75 x 0.50- 316L	
1" x 1/2"	2.000	0.27			SS31-14MP-1 x 0.50- 316L	
1" x 3/4"	2.000	0.27			SS31-14MP-1 x 0.75- 316L	
1.5" x 1/2"	3.000	0.31			SS31-14MP-1.5 x 0.50- 316L	
1.5" x 3/4"	3.000	0.31			SS31-14MP-1.5 x 0.75- 316L	
1.5" x 1"	3.000	0.29	SS31-14MP-1.5 x 1- 304		SS31-14MP-1.5 x 1- 316L	
2" x 1/2"	7.000	0.65			SS31-14MP- 2 x 0.50-316L	
2" x 3/4"	6.000	0.65			SS31-14MP- 2 x 0.75-316L	
2" x 1"	5.000	0.70	SS31-14MP-2 x 1- 304		SS31-14MP-2 x 1- 316L	
2" x 1.5"	3.000	0.40	SS31-14MP-2 x 1.5- 304		SS31-14MP-2 x 1.5- 316L	
2.5" x 1.5"	5.000	0.63	SS31-14MP-2.5 x 1.5- 304		SS31-14MP-2.5 x 1.5- 316L	
2.5" x 2"	3.000	0.53	SS31-14MP-2.5 x 2- 304		SS31-14MP-2.5 x 2- 316L	
3" x 1"	9.000	1.18	SS31-14MP-3 x 1- 304		SS31-14MP-3 x 1- 316L	
3" x 1.5"	7.000	1.24	SS31-14MP-3 x 1.5- 304		SS31-14MP-3 x 1.5- 316L	
3" x 2"	5.000	1.09	SS31-14MP-3 x 2- 304		SS31-14MP-3 x 2- 316L	
3" x 2.5"	3.000	0.75	SS31-14MP-3 x 2.5- 304		SS31-14MP-3 x 2.5- 316L	
4" x 1.5"	11.13	1.17	SS31-14MP-4 x 1.5- 304		SS31-14MP-4 x 1.5- 316L	
4" x 2"	9.125	1.25	SS31-14MP-4 x 2- 304		SS31-14MP-4 x 2- 316L	
4" x 2.5"	7.125	1.50	SS31-14MP-4 x 2.5- 304		SS31-14MP-4 x 2.5- 316L	
4" x 3"	5.125	1.15	SS31-14MP-4 x 3- 304		SS31-14MP-4 x 3- 316L	
6" x 2"	6.875	2.60	SS31-14MP-6 x 2- 304		SS31-14MP-6 x 2- 316L	
6" x 3"	6.875	2.60	SS31-14MP-6 x 3- 304		SS31-14MP-6 x 3- 316L	
6" x 4"	7.000	1.92	SS31-14MP-6 x 4- 304		SS31-14MP-6 x 4- 316L	
8" x 4"	7.500	5.50	SS31-14MP-8 x 4- 304		SS31-14MP-8 x 4- 316L	
8" x 6"	7.750	6.50	SS31-14MP-8 x 6-304		SS31-14MP-8 x 6-316L	



www.sanitarysolutions.com

Sanitary Solutions Inc. 1-888-909-3569 or 1-855-640-7871

Prices are subject to change without notice; please call before you quote

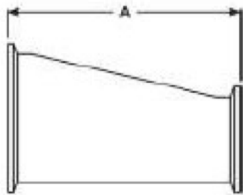
SS32-14MP--- Clamp x Clamp Eccentric Reducer, Polish ID/OD



<u>Tube OD (Size)</u>	<u>A</u>	<u>Weight</u>	Part Number 304 SS 	Part Number 316L SS 
3/4" x 1/2"	2.000	0.25		SS32-14MP-.75 x 0.50- 316L
1" x 1/2"	2.000	0.27		SS32-14MP-1 x 0.50- 316L
1" x 3/4"	2.000	0.27		SS32-14MP-1 x 0.75- 316L
1.5" x 1/2"	3.000	0.31		SS32-14MP-1.5 x 0.50- 316L
1.5" x 3/4"	3.000	0.31		SS32-14MP-1.5 x 0.75- 316L
1.5" x 1"	3.000	0.29	SS32-14MP-1.5 x 1- 304	SS32-14MP-1.5 x 1- 316L
2" x 1"	5.000	0.70	SS32-14MP-2 x 1- 304	SS32-14MP-2 x 1- 316L
2" x 1.5"	3.000	0.40	SS32-14MP-2 x 1.5- 304	SS32-14MP-2 x 1.5- 316L
2.5" x 1.5"	5.000	0.63	SS32-14MP-2.5 x 1.5- 304	SS32-14MP-2.5 x 1.5- 316L
2.5" x 2"	3.000	0.53	SS32-14MP-2.5 x 2- 304	SS32-14MP-2.5 x 2- 316L
3" x 1"	9.000	1.20	SS32-14MP-3 x 1- 304	SS32-14MP-3 x 1- 316L
3" x 1.5"	7.000	1.24	SS32-14MP-3 x 1.5- 304	SS32-14MP-3 x 1.5- 316L
3" x 2"	5.000	1.09	SS32-14MP-3 x 2- 304	SS32-14MP-3 x 2- 316L
3" x 2.5"	3.000	0.75	SS32-14MP-3 x 2.5- 304	SS32-14MP-3 x 2.5- 316L
4" x 1.5"	11.13	1.58	SS32-14MP-4 x 1.5- 304	SS32-14MP-4 x 1.5- 316L
4" x 2"	9.125	1.66	SS32-14MP-4 x 2- 304	SS32-14MP-4 x 2- 316L
4" x 2.5"	7.125	0.75	SS32-14MP-4 x 2.5- 304	SS32-14MP-4 x 2.5- 316L
4" x 3"	5.125	1.15	SS32-14MP-4 x 3- 304	SS32-14MP-4 x 3- 316L
6" x 2"	6.875	2.60	SS32-14MP-6 x 2- 304	SS32-14MP-6 x 2- 316L
6" x 3"	6.875	2.60	SS32-14MP-6 x 3- 304	SS32-14MP-6 x 3- 316L
6" x 4"	7.000	1.92	SS32-14MP-6 x 4- 304	SS32-14MP-6 x 4- 316L
8" x 4"	7.500	6.15	SS32-14MP-8 x 4- 304	SS32-14MP-8 x 4- 316L
8" x 6"	7.750	6.60	SS32-14MP-8 x 6-304	SS32-14MP-8 x 6-316L

www.sanitarysolutions.com

Sanitary Solutions Inc. 1-888-909-3569 or 1-855-640-7871

Prices are subject to change without notice; please call before you quote



SS2SXLMP-- 12" Clamp Sweep Elbow, Polish ID/OD				
Tube OD (Size)	A	R	Weight	Part Number 316L SS
1/2"	12.50	12.00	1.08	SS2SXLMP-0.50-12-316L
1"	12.50	12.00	1.74	SS2SXLMP-1-12-316L
1.5"	12.50	12.00	2.46	SS2SXLMP-1.5-12-316L
2"	12.50	12.00	3.44	SS2SXLMP-2-12-316L
2.5"	12.50	12.00	4.27	SS2SXLMP-2.5-12-316L
3"	12.50	12.00	5.16	SS2SXLMP-3-12-316L
4"	12.63	12.00	8.84	SS2SXLMP-4-12-316L



SS2SXLMP-- 18" Clamp Sweep Elbow, Polish ID/OD				
Tube OD (Size)	A	R	Weight	Part Number 316L SS
1/2"	18.50	18.00	1.28	SS2SXLMP-0.50-18-316L
1"	18.50	18.00	2.44	SS2SXLMP-1-18-316L
1.5"	18.50	18.00	3.56	SS2SXLMP-1.5-18-316L
2"	18.50	18.00	4.95	SS2SXLMP-2-18-316L
2.5"	18.50	18.00	6.12	SS2SXLMP-2.5-18-316L
3"	18.50	18.00	7.46	SS2SXLMP-3-18-316L
4"	18.63	18.00	12.64	SS2SXLMP-4-18-316L

5" & 6" Available-- 30°, 45°, 60° Can Be Quoted



SS2SXLMP-- 24" Clamp Sweep Elbow, Polish ID/OD				
Tube OD (Size)	A	R	Weight	Part Number 316L SS
1/2"	24.50	24.00	1.48	SS2SXLMP-0.50-24-316L
1"	24.50	24.00	3.14	SS2SXLMP-1-24-316L
1.5"	24.50	24.00	4.66	SS2SXLMP-1.5-24-316L
2"	24.50	24.00	6.44	SS2SXLMP-2-24-316L
2.5"	24.50	24.00	7.12	SS2SXLMP-2.5-24-316L
3"	24.50	24.00	9.66	SS2SXLMP-3-24-316L
4"	24.63	24.00	16.14	SS2SXLMP-4-24-316L

5" & 6" Available-- 30°, 45°, 60° Can Be Quoted



SS2SXLMP-- 36" Clamp Sweep Elbow, Polish ID/OD				
Tube OD (Size)	A	R	Weight	Part Number 316L SS
1/2"	36.50	36.00	2.13	SS2SXLMP-0.50-36-316L
1"	36.50	36.00	4.64	SS2SXLMP-1-36-316L
1.5"	36.50	36.00	6.96	SS2SXLMP-1.5-36-316L
2"	36.50	36.00	9.44	SS2SXLMP-2-36-316L
2.5"	36.50	36.00	11.82	SS2SXLMP-2.5-36-316L
3"	36.50	36.00	13.36	SS2SXLMP-3-36-316L
4"	36.63	36.00	24.34	SS2SXLMP-4-36-316L

5" & 6" Available-- 30°, 45°, 60° Can Be Quoted